





COLUMBUS
REGIONAL AIRPORT AUTHORITY

Technology Services

Cabling Standards

Version 2.9



	Version: 2.9	
	Date: 05/2016	
Official Documentation: Cabling Standards		

Disclaimer



The attached electronic document is an instrument of service prepared by Columbus Regional Airport Authority (CRAA) Technology Services and is being provided solely as a convenience to the user. **Technology Services makes no representation regarding fitness for any particular purpose. Due to the easily alterable nature of electronic documents, through either intentional or unintentional means, Technology Services does not make any express or implied warranty for the accuracy or completeness of this information.** The SharePoint source document shall prevail in any dispute over accuracy or sufficiency of electronic documents. By and through its use of the information contained hereon, the user agrees to indemnify and hold Technology Services harmless from any loss, damage, liability or cost, including reasonable attorney's fees, arising from any use or reuse of any electronic document or information.

Disclaimer	2
Purpose.....	6
Referenced Standards	7
Submittals	8
Installer Requirements Installers must satisfy the following requirements: .10	
Panduit Certified Installer (PCI)	10
Corning Cable Systems Certified Installer (NPI)	11
CRAA Additional Requirements	11
Approved Manufacturers:	11
Approved Materials:	11
Telecommunications Outlet.....	12
Quantities and Locations	12
Types and Parts	12
Surface Mount Box (Single or Dual port)	13
Surface Raceway and Vertical Outlet Pole	14
Single Channel Surface Raceway System.....	14
Fittings.....	14
Outlet Boxes	14
Labeling	15
Labeling Elements	15
Face plate labeling format	16
Labeling Horizontal Cables (Copper/Fiber)	17
Rack Labeling	18
Patch Panel Labeling (TR).....	18
Labeling Fiber Backbone.....	21
Labeling Pathways	21
Cabling	22
Horizontal Cabling	22
Backbone Fiber Cabling	22
Backbone Copper Cabling	24
Conduit (at Outlet)	24
Horizontal Cabling Outdoor (copper & fiber).....	24
Abandoned Cable	24
Telecommunication Cabinet (TC)	25
Telecommunications Room (TR)	25
Racks (TR)	26
Ladder Rack (TR)	27
Fire Suppression (TR)	28
HVAC (TR).....	28
Electrical Power (TR).....	28
Lighting (TR)	28
Cable Management (TR).....	30

Copper Patch Cables (TR)	30
Fiber Patch Cables	30
Patching In Telecommunication Rooms (TR)	31
Grounding	33
Grounding Basket Tray.....	34
Pathways (INDOOR)	34
Horizontal Conduit Pathways & Sleeves (Copper).....	36
Fire Rated Horizontal Pathways	36
Fire Rated Riser Pathways	37
Cable Entry.....	37
Data Center & Parts	38
Racks.....	38
Cable Tray for Racks	43
Cabinets.....	46
Data Center Labeling	48
Glossary of Terms	50
Appendix A: Approved Manufactures.....	51
Appendix B: Acceptable Materials List	52
APC	52
BRADY	52
BROTHER	53
CADDY	53
CODE BLUE	54
COMPULINK/CORNING	54
COOPER / B-LINE	55
COOPER/CROUSE-HINDS	59
CORNING	61
GEIST	64
HARGER	64
HOFFMAN/PENTAIR	64
HUBBEL	65
ITW LINX	65
L-COM	66
MAXCELL	66
MIDDLE ATLANTIC	66
PANDUIT	67
SIEMON	72
STI	73
SUPERIOR ESSEX	74
Appendix C: Data Sheets.....	75
INDEX.....	76
Document Version Information.....	78

	 COLUMBUS <small>REGIONAL AIRPORT AUTHORITY</small>	Version: 2.9	
		Date: 05/2016	
Official Documentation: Cabling Standards			

Revision History78
Document Control79

	Version: 2.9	
	Date: 05/2016	
Official Documentation:	Cabling Standards	

Introduction



This document includes and/or references all relevant standards to support, maintain, and install a structured cabling system.

Multiple manufacturer sources for each infrastructure category were selected and compared. A single source manufacturer for each category was selected by comparing quality, cost, and product line and/or product uniqueness that meets CRAA's needs. To maintain a standard installation the selected manufacturer's approved products listed in this document must be installed exclusive. No changes to the approved manufacturer's parts list will be made unless there are repeated supply issues, design inadequacies or product quality changes. All product changes must be approved by a CRAA representative before installation. This document is updated annually. New special application products may be introduced in the Cabling Elements Document provided with the design drawings and can only be used for that particular project. New products proving to be worthy in the Cabling Elements Document will be introduced in the Cabling Standards Document's annual update.

Installation vender selection is based on the ability to meet manufacturer (warrantied work) & CRAA requirements (BICSI & Manufacturer Trained installers). The installation vender selection guidelines are established to provide CRAA with the best qualified venders which reduces the possibility of an unsatisfactory installation. Instalation vender guidelines are spelled out in the "Installer Requirements" section of this document.

Purpose

The purpose of this document is to provide manufacturer's specific standards. This will guide the installation process with specific elements involved in an acceptable Columbus Regional Airport Authority (CRAA) structured cabling system. This document will present manufacturer's installation guidelines and part descriptions. The intent is to be detailed enough to eliminate any confusion as to what is expected by CRAA. It is the installer's responsibility to make bids, quotes, or proposals compliant with the most recent version of this document. The standards in this document replace all previous standards. This document makes no guarantee that it is 100% up to date with the manufacturer's requirements for warranties. The installing company has the ultimate responsibility to be knowledgeable of any changes to



	Version: 2.9	
	Date: 05/2016	
Official Documentation: Cabling Standards		

warranty requirements. All exceptions to and variances from this document require CRAA approval.

Referenced Standards

The design of the system and the selected equipment will conform to the following standards where applicable. It is assumed that all installers engaged in the installation and service of the network have access to and knowledge of the following current standards. It is the responsibility of the installer to be knowledgeable of all Federal, State, and local codes. If any of the standards conflict with any codes then the most stringent apply.

- Americans with Disability Act Accessibility Guidelines for Buildings and Facilities (ADAAG)
- American National Standards Institute (ANSI)
- American Society for Testing and Materials (ASTM)
- American Standards Association (ASA)
- Building Industries Consulting Services International (BICSI) Telecommunications Wiring Standards
- Building Officials and Code Administrators (BOCA) International Inc. Basic Building Code, BOCA Basic Plumbing Code, BOCA Basic Mechanical Code
- Electronics Industry Association/ Telecommunication Industries Association (EIA/TIA) 568/569/606/607
- FCC Codes and Regulations
- Institute of Electrical and Electronics Engineers (IEEE), especially IEEE 802.2 and 802.3, 1100-19992 (Powering and Grounding)
- International Telecommunications Union (ITU)
- National Board of Fire Underwriters (NBFU)
- National Bureau of Standards (NBS)
- National Electric Code (NEC)
- National Fire Protection Association (NFPA) 101 Life Safety Code
- State Electrical Code and/or National Electrical Code (NEC)
- State Building Code
- Rural Electric Association - Telephone Division Standards
- Underwriters Laboratories, Inc. (UL), Federal Specifications
- Williams-Steiger Occupational Safety and Health Act of 1970 (OSHA) - Public Law 91-596
- International Electro technical Commission (IEC) Standard 60529
- National Electrical Manufacturer's Association (NEMA) Standard 250

	Version: 2.9	
	Date: 05/2016	
Official Documentation:	Cabling Standards	

Submittals

- **Pre-Installation**

Information submitted at the time of Bid, Quote, or Proposal.

- **Installer Requirements (proof of current certifications):**

-Employee Certifications

1. Two fulltime employed RCDD's.
2. On site supervisors is a BICSI Technician.
3. 100% Employees performing terminations are BICSI and/or Manufacturer certified.
4. Minimum of 50% onsite installers are BICSI certified.

-Company Certifications

5. Panduit PCI current certification (valid for two years).
6. Corning NPI current certification.

-Documentation listing all Part Numbers, Quantities, MSD Sheets. For parts not listed in the standards document include Installation Instructions, Spec Sheets, Tools and Methods of Installation of all elements.

Important: Approval is contingent upon installer's employees obtaining CMH identification badges. Please contact the CRAA ID office for badge cost and identification requirements. Note: Separate LCK identification may be required.

- **Post-Installation**

All deliverables must be delivered within 30 days of project completion.

Test results

1. All test results will be provided in LINKWARE and PDF format.
2. Copper - Hardcopy and electronic version will be provided from a Fluke tester only (field test results must contain all test data and not a modified electronic version). Model Fluke DSX-5000 CableAnalyzer preferred, other models must be approved by CRAA.

3. Fiber (Single Mode) - Hardcopy and electronic version is to be supplied (field test results must contain all test data and not a modified version). Fiber is to be tested with dual wavelengths (1310 nm, 1550 nm) in both directions. If requested by CRAA, OTDR tests results will be provided in both directions for every fiber (OTDR test results will be required if any splices are done).

Format for saving test results as follows:

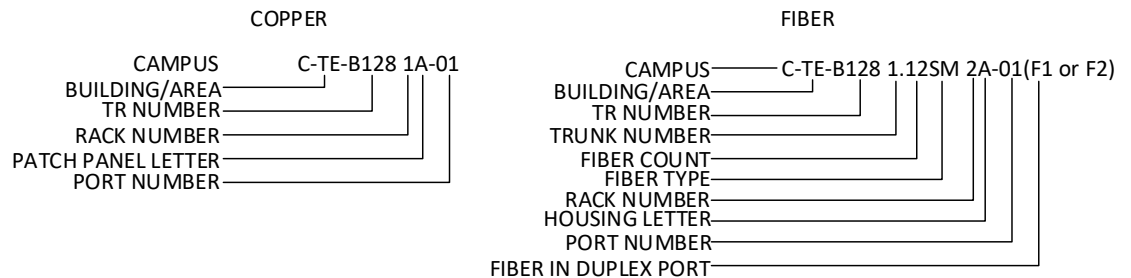



As Built Drawings

New construction, remodeling, or MAC installations require "As Built" drawings.

All drawings will show:

1. Horizontal Cabling
2. Back Bone Cable
3. Pathways (including size and type)

	Version: 2.9	
	Date: 05/2016	
Official Documentation: Cabling Standards		

4. Pull Boxes & Manholes
5. Fire Stop Pathways

All elements of the cabling infrastructure will be labeled on the prints as indicated in this document.

For new installations one set of 24in x 36in drawings will be posted in the TR for which the work was completed in and an electronic version of the drawings will be provided in CAD & PDF format. For all other installs red lined PDF drawings will be acceptable.

Warranties

- Panduit® Certification PlusSM System Warranty
The installer will provide the original copy of this certification.
The certification will be for a 25 year Warranty.
- Corning Warranty
The installer will provide the original copy of this certification.
The certification will be for a 25 year Warranty.



Installation is Complete When:

1. All items on the Punch Out list are complete.
2. All Post-Installation items and copies of the Pre-Installation items are provided.
3. Photographs of all fire pathways and outside plant access points have been provided.
4. Telecommunication Grounding Bus bar TGB resistance to ground test results (if new build).
5. All items above have been reviewed, & approved by CRAA.

Installer Requirements Installers must satisfy the following requirements:

Panduit Certified Installer (PCI)

- Decision to offer PCI status is determined by the local sales team (Sales Rep, DSM, and RVP).
- Minimum Staffing Requirements:

 COLUMBUS <small>REGIONAL AIRPORT AUTHORITY</small>	Version: 2.9	
	Date: 05/2016	
Official Documentation: Cabling Standards		

- Two (2) individuals or 20% of their techs, whichever is greater, on staff who are Panduit Certified Copper Technicians
- Two (2) individuals or 15% of their techs, whichever is greater, on staff who are Panduit Certified Fiber Technicians
- PCIs must maintain full-time technicians as direct employees as opposed to only working through sub-contractors.
- One (1) full-time RCDD on staff.

Note: PCI certification is valid for 2 years.

Corning Cable Systems Certified Installer (NPI)

- Dated certificate of acceptance must be provided.

CRAA Additional Requirements



- The installer must employ a minimum of two full-time RCDD’s with current certifications. The onsite supervisor must have a minimum BICSI Technician certification. There must be a minimum of 50% total on site installers having BICSI certification. Terminations must be performed by 100% BICSI and/or manufacturer certified installers. All certifications must be current and copies presented at time of pre-installation submittal.

Approved Manufacturers:

Please see [Appendix A](#) for a list off all approved Manufacturers.

Approved Materials:

Please see [Appendix B](#) for a list of all approved Manufacturers.

	Version: 2.9	
	Date: 05/2016	
Official Documentation:	Cabling Standards	

Telecommunications Outlet

The telecommunications outlet is the physical interface (typically RJ-45 female for copper) in the horizontal cabling system into which a network patch cable is usually connected. It is also sometimes referred to as a network "Module", "jack" or "port".

Quantities and Locations

- 2 jacks per Office
- 2 jacks per Cubical
- 1 jack per Printer
- 1 jack per Wireless Access Point
- 1 jack per AMAG
- 1 jack per TUGMAN
- 1 jack per Key Box
- 1 jack per METASYS
- 1 jack per Time Clock

Types and Parts

- Face plate (one gang or two gang)
- Face plate will have the top half blanked off.
- Face plate will have jacks in the bottom ports only (to allow for proper bend radius of the cable).
- Face plates will be Off White in color
- Face plates will attach to:
 - A Low voltage wall board adapter capable of replacing an electrical box in Class 2 low voltage installations (with a deep internal wall clearance).
 - Deep two gang electrical outlet box with a one gang reducer plate.
 - Deep low voltage surface mount outlet box
- **Note:** Exiting outlet box from the side and bottom of the box should be avoided if possible.
- Jacks at the outlet will be Cat 6A yellow and terminated 568B.
- Special applications face plates and outlets.
 - Water resistant face plates will be used for indoor applications when the environment is excessively dirty and exposed to

moisture. These locations will include but not limited to maintenance garages or areas where garage doors are located.
 -All water resistant face plates will be installed onto deep outdoor rated outlet boxes when surface mounted boxes are used.

-A security face plate will be used on any public-area outlet and whenever its location is publically accessible.

-NEMA 4X outlet will be used in extreme environments where outlet will be exposed to the elements or where an outlet is not contained in a NEMA 4X enclosure.

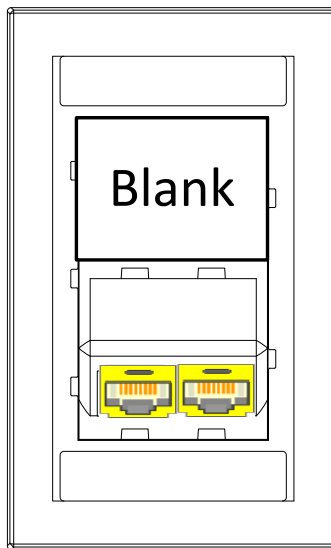



Typical One Gang Face Plate Assembly

Surface Mount Box (Single or Dual port)

- Use Two Port Surface mount boxes in all other applications unless specified. Color to be specified by CRAA (black or off white)
- Use One Port Surface mount boxes for Metasys, AMAG, Key Box, Time Clock, and where specified in other areas.

See [Appendix B](#) for all related part numbers.

	Version: 2.9	
	Date: 05/2016	
Official Documentation: Cabling Standards		

Surface Raceway and Vertical Outlet Pole

“Surface raceway and vertical outlet poles” refers to a surface raceway system used for branch circuit wiring and/or data network, voice, video and other low-voltage cabling. Surface raceway will be used in solid wall applications or for applications where fishing the wall is not an option. The raceway system will consist of raceway, appropriate fittings and accessories to complete installation per electrical and/or data drawings. Non-metallic surface raceway is to be utilized in dry interior locations only, as covered in Article 388 of the NEC, as adopted by the NFPA and as approved by ANSI. No fittings will be used that violate the minimum bend radius requirements of the cable (4 x the outside diameter of the cable for cat6 A). See [Appendix B](#).

Single Channel Surface Raceway System

Single Channel Surface Raceway will be a one piece design. Raceway dimensions will be: 1.51” wide x 0.94” deep with an approximate wall thickness of 0.055”. The raceway will be available in 6', 8' and 10' lengths, have a tamper resistant hinge attaching the cover to the base, and have tamper resistant non-slip cover design. The raceway will be manufactured of rigid PVC compound, have a smooth texture, and be available in the color off white.

Fittings

A full complement of fittings (LD10 series) must be available including but not limited to entrance fittings, couplers, and end caps. The fittings will provide a means for connecting to the raceway and will be capable of maintaining a 1.25” minimum cable bend radius. Applicable fittings will be of cover only design (for low voltage cabling only), or base and cover design in order to maintain complete enclosure and to eliminate mitering.

Outlet Boxes

The junction boxes will be available in one gang deep version. The boxes will be available in the color off white and match the raceway.

Labeling

Labeling Elements

Patch Panel Port Number

- 01 to 48

Patch Panel Identifier

- A to ZZ

Building/Area (Columbus Airport)

- AF-ARFF
- AM-Airfield Maintenance
- BC-Blue Covered Lot
- BL-Blue Lot
- BP-Baggage Pickup
- CH-CEO House
- CB-Crossover Bridge
- DC1-Data Center CMH
- EL-Employee Lot
- EV-Electrical Vault
- GL-Glycol
- GE-Garage Entrance Plaza
- GR-Green Lot
- GS-Guard Shack
- LA-Lane Aviation
- NT-New Tower
- OT-Old Tower
- PG-Parking Garage
- PT-Police Training
- RL-Red Lot
- SB-Shuttle Bus
- SR-Shipping/Receiving
- TE-Terminal
- TO-TOC

- NM- North Matrix (Inline Baggage)
- SM- South Matrix (Inline Baggage)

Building/Area (Bolton Airfield)

- TE-Terminal
- A1-Aircraft Maintenance 1
- A2-Aircraft Maintenance 2
- SR-Snow Removal
- M1-Maintenance Building 1
- M2-Maintenance Building 2
- TA to TI- T Hangers (A to I)
- PA-Pavilion

Building/Area (Rickenbacker Airport)

- FB-Fuel Base Operations (Building #532)
- TE-Terminal
- SR-Snow Removal
- NT-North Tower

Campus

- B- Bolton Airfield (TZR)
- C- Columbus Regional Airport (CMH)
- R- Rickenbacker Airport (LCK)

Face plate labeling format

The top label has the:

- Campus
- Building/Area
- TR Room Number (Sector, Floor, Room, and Sub Sector)

The bottom label consists of:

- Rack Number
- Patch Panel Letter
- Patch Panel Port Number for two Jacks
- (F) For Fiber Outlets

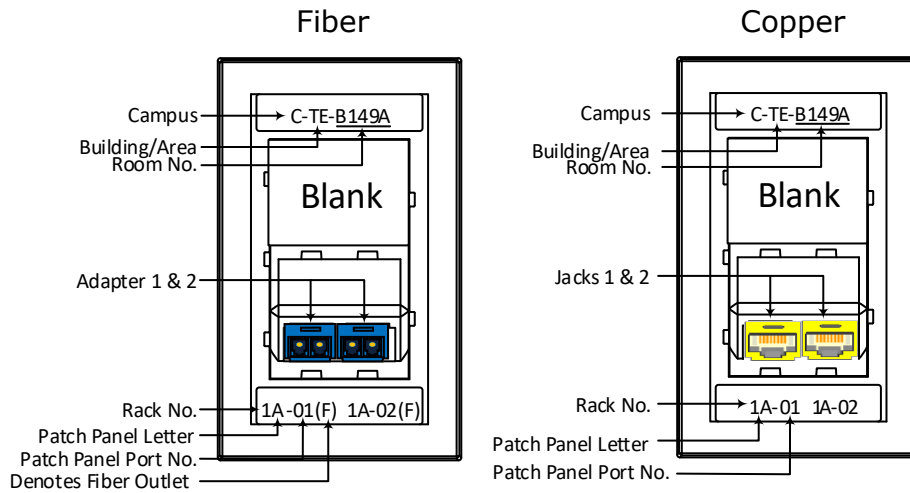

Typical Faceplate Labeling Format

Labeling Horizontal Cables (Copper/Fiber)

Cable runs have a unique matching identifier at each end of the cable. The unique identifier is mechanically generated on a self-laminating wraparound label. One label will be placed 12 inches back from the faceplate jack and three inches back from the patch panel jack. All wraparound labels will have the same information that is on the face plate. The first line on the label will have **Campus – Building or Area** (example: Red Lot) - **TR Room Number**. The second line on the label will consist of **Rack Number - Patch Panel Letter - Patch Panel Port Number – (F)** if fiber drop.

Copper Label

Fiber Label (4 strand MIC cable)

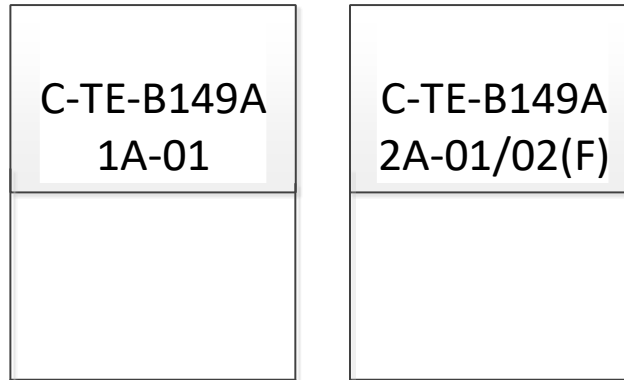

Cable Label

Rack Labeling

Each rack will be labeled with **Campus – Building** or **Area - TR Room Number** on the top left corner of trough. Each rack will be labeled with the **RACK – Rack Number** on the top right corner of the trough. All labels will be five inches long by 3/4 high using “HELSINKI” style print #36 size. Rack labels will have white vinyl labels (Brother TZe-S241) with black lettering. See [Appendix B](#) for an approved rack. Rack 1 will be the rack closest to the wall in the TR.



Rack Labels

Patch Panel Labeling (TR)

Label all patch panels and LIUs with an alpha identifier. Determine the alpha identifier by the location of the patch panel or LIU on the rack. Label the top RU "A", label the second RU down AA, label the third RU down B, and label the fourth RU down BB and so on. Patch Panels and LIUs will take the alpha identifier of the top RU that it occupies. Data Jacks will be CAT6A yellow and voice feed jacks will be black CAT3 (both will be terminated 568B).

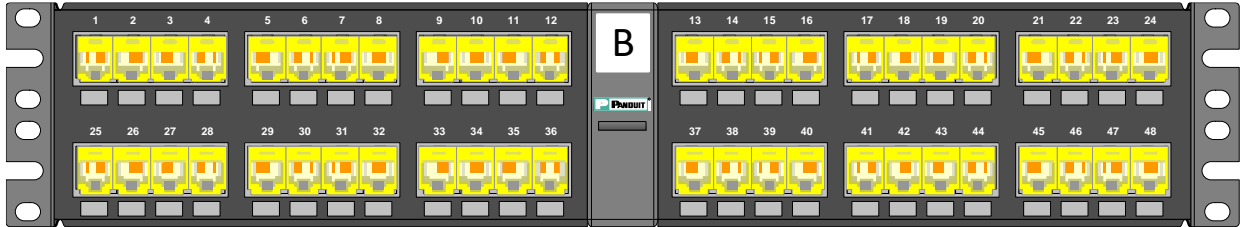

Patch Panel Labeling



Official Documentation: **Cabling Standards**

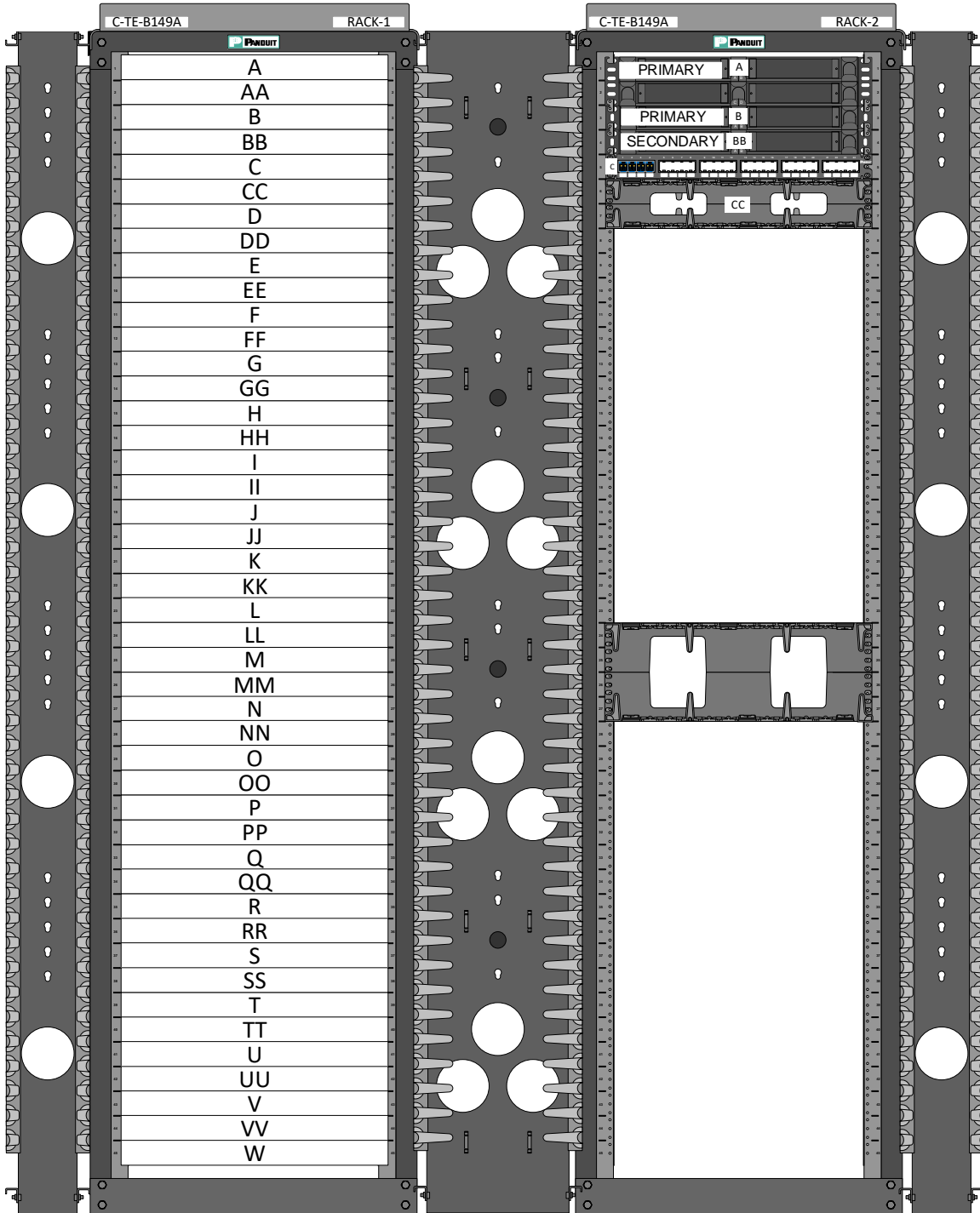

RU LABELS IN A 45RU RACK

EXAMPLE OF LIU LABELING

Labeling Fiber Backbone

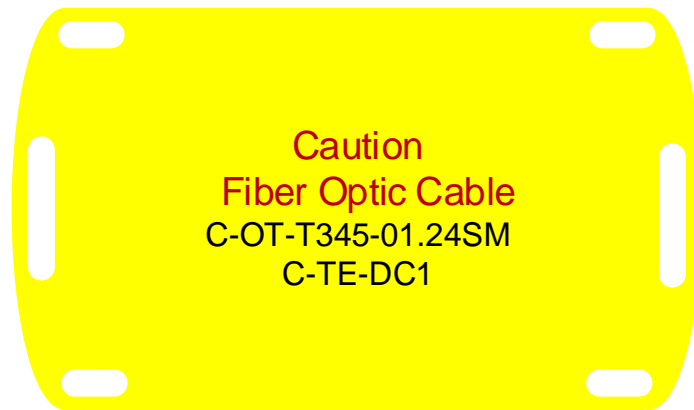

All fiber backbone cable will be labeled as illustrated below. Each fiber backbone cable will have a self-laminating weather proof yellow tag attached at the beginning, at the end and all pull points in between. The unique identifier will be labeled in the following order: **"Caution Fiber Optic Cable"**& **Campus 1-Building or Area 1-Room Number 1(highest number goes first)-Trunk Number. Fiber count & Fiber Type(SM for single mode). Campus 1-Building or Area 2-Room Number 2(highest number goes first)** See [Appendix B](#) for approved label part numbers.



Fiber Backbone Label (intrabuilding & interbuilding)

Labeling Pathways

All cable pathways will be marked with a self-laminating weather proof yellow tag attached as illustrated above. Every 10 feet a tag will be placed on each side of the basket tray (a tag will be attached to the bottom of the basket tray when the side tags will not be visible). When a pathway is comprised of J-hooks only, a tag will be placed every other J-hook.

	Version: 2.9	
	Date: 05/2016	
Official Documentation:	Cabling Standards	





Cabling

Horizontal Cabling

All cable runs throughout a site will be done in accordance to the cable and module connector manufacturer’s specifications to maintain the integrity of the run. Wire damaged through poor installation such as incorrect bends, kinks, knots, friction burns, smashed or installed on/near sources of EMI must be removed and replaced with properly installed cable runs. The length of the copper horizontal cabling connecting a telecommunications outlet to patch panel in the TR must not exceed 90 meters or 295 feet (the maximum distance as specified in the ANSI/TIA/EIA 568-B standards for Category 6A cabling). This cable must be plenum Category 6A performance at 500MHz and yellow in color. The yellow colored cable is reserved for the exclusive use of CRAA voice and data network. Each outlet will have a 10 foot service loop (not a coil). The service loop will be supported by CRAA-approved J-hooks. The minimum cable length will be 50 feet.

Backbone Fiber Cabling

All fiber will be single mode (OS2) with LC or MTP connectors in the TR. Outdoor or Indoor/Outdoor fiber will be Gel-Free OS2 with MT or LC connectors. The same manufacturer will be used for fiber, connectors, and all fiber connecting hardware. All fiber passing through a manhole or outdoor pull box will have a 25 foot service loop. The service loop will not exceed the manufacturer’s minimum bend radius requirements. Service loops will be supported by an outdoor rated hanger and located free and clear of the opening. All work requiring entry into a manhole or any other confined space

	Version: 2.9	
	Date: 05/2016	
Official Documentation: Cabling Standards		

will require the installer to be compliant with CRAA’s Confined Space Program. Contact our *Safety and Health Specialist* for details regarding compliance. All intrabuilding backbone cable to TRs will consist of a minimum of two twelve-strand fiber trunks. The trunks will take two separate pathways to provide redundancy. All interbuilding backbone cable terminated in an outdoor location will be terminated in a weather proof environment (NEMA 250 Type 4X & ICE 529 IP66 Rating). The fiber pathways will be defined by CRAA. See [Appendix B](#). for approved fiber products.

- **Indoor Backbone Cable**
All indoor fiber will be a pre-terminated optical fiber cabling system designed for building backbone. The trunks will be armored cables and maintain electrical continuity across their entire length. The armored cables will have a grounding wire bonded at both ends and be grounded to the TGB. All fiber will be Plenum rated cable
- **Indoor/Outdoor Backbone Cable (4300 feet or less)**
All indoor/outdoor fiber will be pre-terminated optical fiber cabling system designed for building backbone. The cable solution will provide a water tight connection MT at the main cross connect (Data Center) and at the TR. All fiber will be riser-rated cable.
- **Indoor/Outdoor Backbone Cable (Greater than 4300 feet)**
All Indoor/outdoor fiber will be fully water blocking loose tube gel-free design. It will have a medium-density polyethylene jacket with an all-dielectric cable construction (requiring no bonding or grounding). All terminated fiber will have an Outdoor Buffer Tube Fan-Out Kit installed regardless if it is terminated indoors or outdoors. Field terminated cable can only be used when the fiber pull distance exceeds pre-terminated fiber length limits or there are conduit size restrictions. All fiber will be riser-rated cable. May be substituted for Indoor/Outdoor Backbone Cable (4300 feet or less) when necessary and approved by CRAA.
- **Outdoor rated fiber can be used for special applications with special approval from a CRAA design representative. All outdoor cable will not**

be run indoors further than 50 feet without being in conduit. See [Appendix B](#) for approved fiber.

All Out Side Plant (OSP) cabling will require evaluation and standards created on an individual basis because of its unique nature.

Backbone Copper Cabling

All primary backbone cabling will be Cat5e riser rated cable and all secondary backbone cable will be Plenum rated cable. There will be a minimum of two primary and two secondary backbone cables per TR.

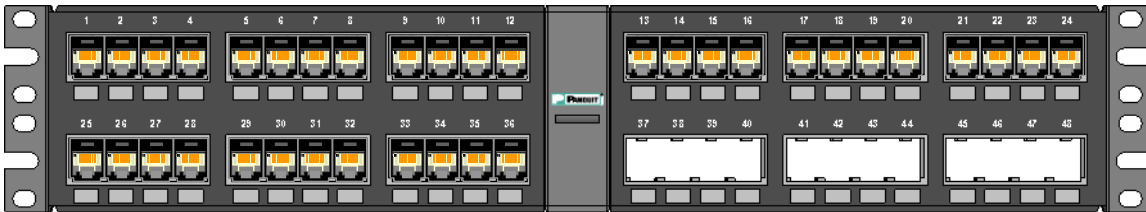

Conduit (at Outlet)



Whenever conduit is used the minimum size for one work station (two data cables) is one inch trade size. All stubbed out conduits will have bushings installed before installing cable. The junction box requirement is a deep two gang box with a one gang reducer.

Horizontal Cabling Outdoor (copper & fiber)

All cable that travels below grade (regardless if it is inside a structure) will be outdoor-rated cable. Outdoor copper cable will be Cat6A gel filled corrugated copper-clad steel armor see [Appendix B](#) approved cables. All outdoor cable terminations will be housed in a climate controlled telecommunications building or a weather-proof cabinet (see "Telecommunications Cabinet" below). All OSP copper cabling entering a building will be terminated within 50 feet of entering a building (preferably as soon as it penetrates the exterior wall). All outdoor copper cabling will have a CRAA-approved primary surge protector installed at each end of the cable and properly grounded to manufacture specifications.

Abandoned Cable

All cable that is replaced by new cabling will be removed back to the point of termination. All cable, jacks, faceplates, surface mount boxes, etc. that are

 COLUMBUS <small>REGIONAL AIRPORT AUTHORITY</small>	Version: 2.9	
	Date: 05/2016	
Official Documentation: Cabling Standards		



obsolete will be removed. All faceplates that are removed will be blanked off. All copper cabling that is removed will be returned to CRAA for recycling.

Telecommunication Cabinet (TC)

A **weather proof cabinet** is defined as an enclosure being rated to NEMA 4X and IEC IP66. A weather proof enclosure should be used as a last resort. The telecommunication Cabinet (TC) should be located at the center of a 150 ft. radius of the area serviced. When a weather proof enclosure is used it should contain a moisture absorbent material that can be changed periodically. The weather proof enclosure will have all conduit penetrations packed with fireproof putty to prevent moisture intrusion. The company that is installing the electronic equipment will provide specifications for acceptable temperature and humidity ranges for all equipment. The installing company will be responsible for implementing the equipment that can function in this environment. The enclosure will have an environmental monitoring system that is connected to CRAA’s network. If a cooling unit is installed on a weather proof enclosure it will be a closed-loop cooling system.

Telecommunications Room (TR)

There are typically one or more rooms per floor in a building. The telecommunication room should be located at the center of a 175 ft. radius of the area serviced. The Horizontal cabling length from patch panel (in the TR) to outlet will not exceed 295 ft. There needs to be a 10 ft. service loop at the TR for all horizontal cabling. A 20 ft. service loop is required for all fiber backbone cabling located in the TR. The TR space is secured such that only authorized personnel are allowed entry. The access door to the TR will be card access plus pin with a key override. The entry door will be a minimum of 3 ft. wide and 7 ft. high without doorsills and windows, and hinged to open outward (code permitting). These spaces will not be dual-purposed or shared with anything (such as supply rooms). The size of the TR will not be smaller than 10 x 12 (10x16 preferred) and will be larger based on the number of locations served. A minimum of three 19-inch racks (four posts) should fit in the space with 3 feet of clearance on the front and back of equipment. The rack nearest the wall will have twelve inches of clearance between the side of the wire manager and the wall. TR rooms should not have drop ceilings and the minimum allowed ceiling height is 10 ft. All TR’s

	Version: 2.9	
	Date: 05/2016	
Official Documentation: Cabling Standards		

will have a wall phone located near the doorway centered at 46 inches high. All walls (if not block or concrete) will be covered with dry wall and then $\frac{3}{4}$ inch fire rated plywood Class 1 per ASTM E84-01 Standard test Method for Surface Burning Characteristics of Building Materials. All plywood will be installed finish side out with the 8 ft. side vertical and 12 inches off the floor. If plywood is painted, then one fire rating stamp on each sheet will be left unpainted (preferably up towards the top of the sheet). If plywood is painted then two coats of white fire proof paint will be used (codes permitting painting). The room will not have water pipes, drain pipes, and sprinkler pipes passing through. All walls will extend to the decking and have a minimum of a one hour fire rating.

Racks (TR)

Racks will have 45 rack units (RU's) of space for equipment, wire management, and patch panels. They will have a black finish and support 19" rack mount equipment. Each rack will be grounded to the TR bus bar. There will be a total of three racks installed in a standard TR build out. Rack 1 will be used for copper patch panels. Rack 2 will be used for fiber backbone and network switches. Rack 3 will be reserved for miscellaneous equipment and cabling supported by the network (this rack is optional depending on the need in the service area).



Official Documentation: **Cabling Standards**

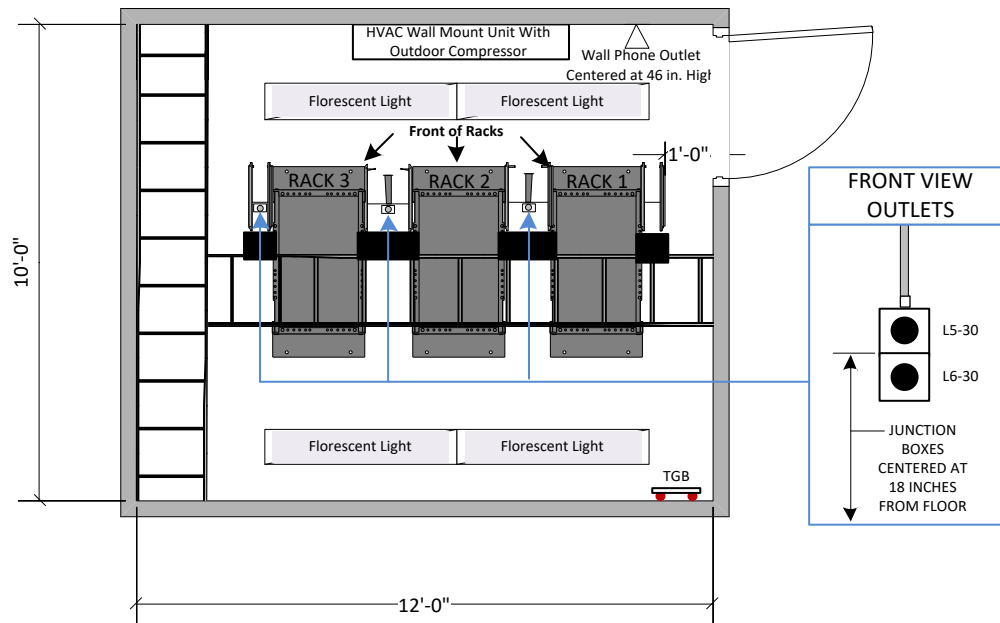

- Note:**
- Keep florescent Lights a minimum of 3 ft. away from racks & ladder rack
 - Lights wired to backup power
 - All walls covered with void free A/C grade plywood mounted finished side out. Fire rated plywood will be used and painted with white fire-retardant paint (two coats). Plywood will be mounted 8 ft. side vertical and 10 in. off the floor.
 - All electrical outlets will be cut into the plywood at standard outlet height (18 in.).
 - All electrical outlets and corresponding breaker panels will be labeled with a machine generated label.

Typical Telecommunication Room

Ladder Rack (TR)

All data ladder rack attaching to the four post racks will be 18 inches wide and supported a minimum of every 5 feet.

Fire Suppression (TR)

The fire protection system and hand-held fire extinguishers will comply with NFPA & all local codes. When sprinkler systems are required by code, the room's solution should be a pre-action system. The preferred fire suppression system (if code allows in place of a sprinkler system) is a gaseous total flooding extinguishing system (an example would be FM200). If code requires a sprinkler system, the CRAA preferred solution is to have both systems in place to limit the possibility of water damage by using the pre-action system as a backup. A hand-held fire extinguisher will be available in the room regardless of the fire suppression systems used.

HVAC (TR)

The ambient room temperature and humidity should be controlled 24 hours a day, 365 days per year at temperatures between 64 and 75 degrees Fahrenheit, 30 and 55 percent humidity, positive pressure with independent power from telecommunications equipment.

Electrical Power (TR)

There will be a minimum of three L6-30R and three L5-30R installed. Each outlet will be on a separate circuit breaker and connected to the building's main UPS, which will be provided for equipment power. If the building UPS is not available then the outlets will be connected to the generator backup and our standard rack mounted UPS will be used. The circuits will be routed down to the back of the vertical wire manager. The outlets will be centered at standard outlet height (18 inches). All power installed on data racks will be ran in EMT. All conduit and hardware installed on data racks and ladder racks will be black or painted flat black. There will be no fasteners exposed or protruding into the vertical wire managers, a precaution to avoid cut or damaged patch cords.



Convenience duplex 5-20R outlets should be placed at 6 ft. intervals around the perimeter walls, at a height that is customary for each installation site (usually centered at 18 inches).

Lighting (TR)

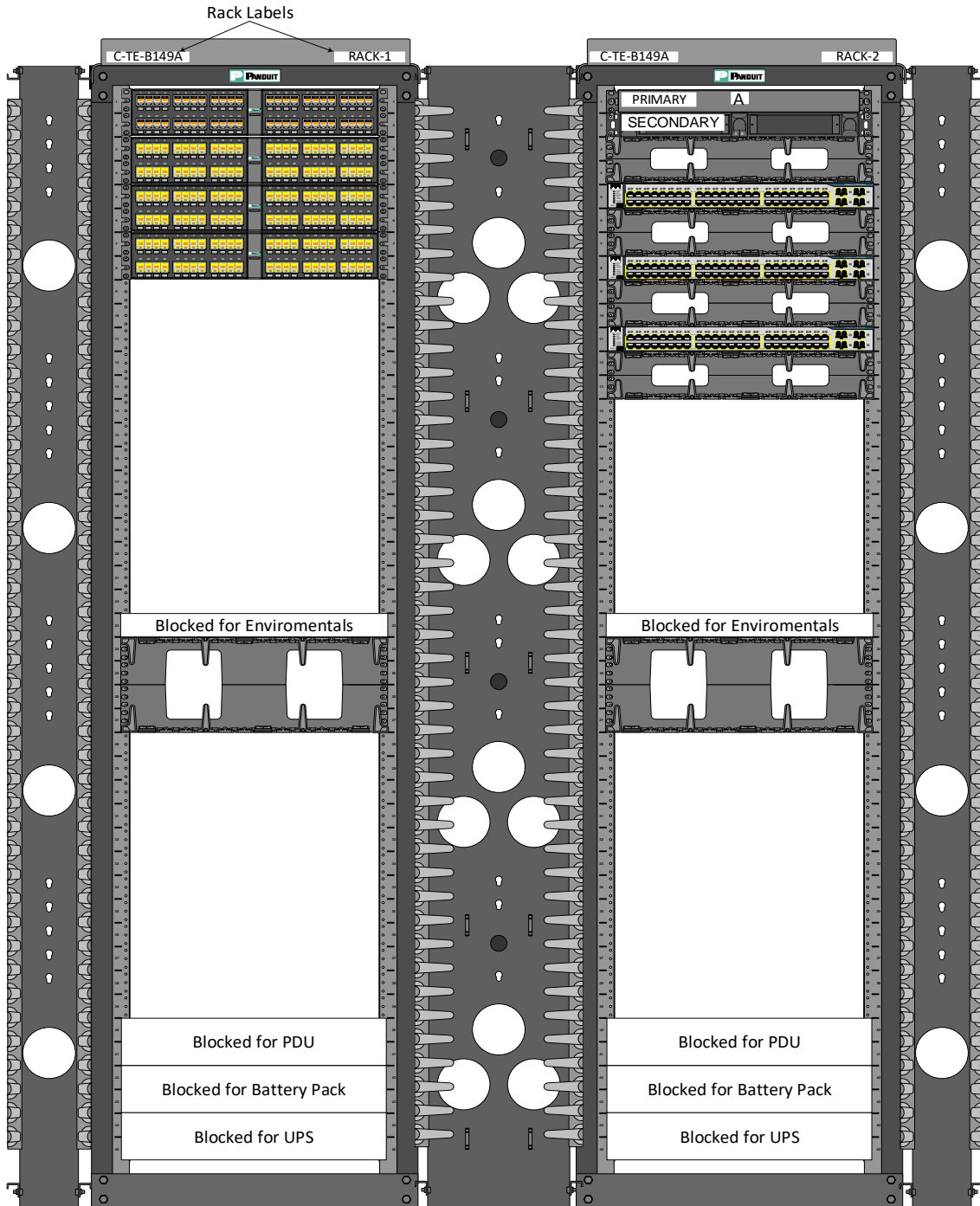
Lighting should be a minimum of 500 lx (50 foot candles) measured at the point of termination. Light switches should be easily accessible when entering the room. Lights will be wired to emergency backup power.



Typical Rack and Cable Management Layout with Labels

 COLUMBUS <small>REGIONAL AIRPORT AUTHORITY</small>	Version: 2.9	
	Date: 05/2016	
Official Documentation: Cabling Standards		

Cable Management (TR)

Vertical cable managers are required between all racks and at the end of each rack, which means two racks side by side will have three vertical cable managers (one on each end and one between the racks). Horizontal cable managers will be used between Switches to provide for proper cable management. See drawing above for typical rack and cable management layouts. The approved cable managers are listed in [Appendix B](#).

Copper Patch Cables (TR)

The equipment cords and patch cords will be chosen to match the horizontal cabling medium and rating. The manufacturer that provides the horizontal cabling and jacks will provide the patch cords. The total patch cord length at the work area is not to exceed ten feet. All patch cords for data will be yellow Cat6A and all voice patch cords will be black Cat6. All pass through patches to a tenant location will be yellow Cat6A regardless if it is voice or data. Label both ends of the patch cords the same way the horizontal cabling is labeled.

Fiber Patch Cables

The manufacturer that provides the fiber, connectors, and connecting hardware will provide the patch cords. All fiber patch cords will be single mode (OS2) with duplex LC to LC connectors or LC to SC duplex connectors (were equipment requires).

For Patch cord lengths please see the following drawings for two rack and three rack patching. All rack mounted equipment that is patched into the network switches will be patched to the back of a patch panel using a Cat6A coupler (start with port 48 and work backwards). Label all patch cords from rack mounted equipment to the back of a Cat6A coupler the same way as horizontal cabling.



Patching In Telecommunication Rooms (TR)

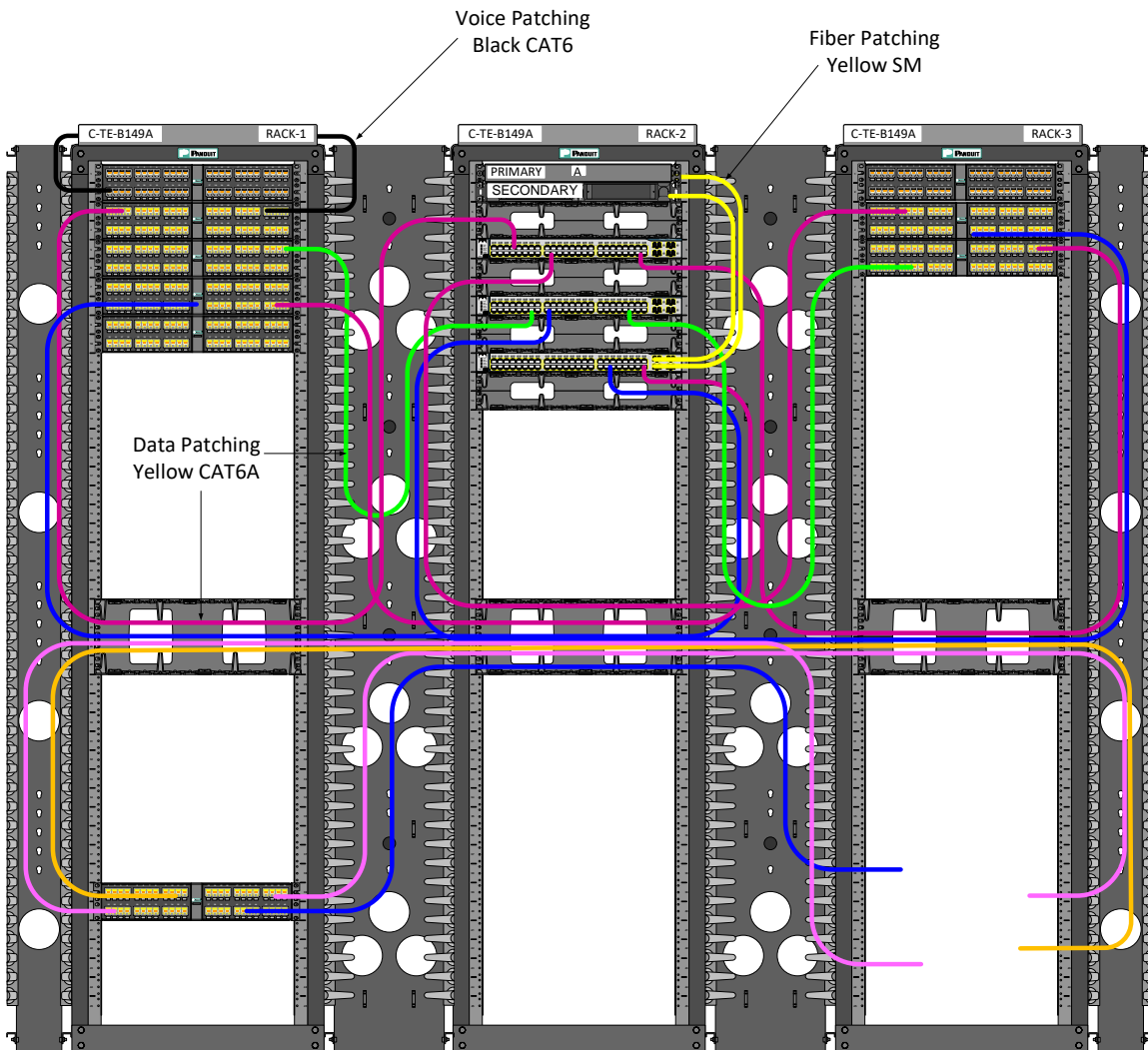

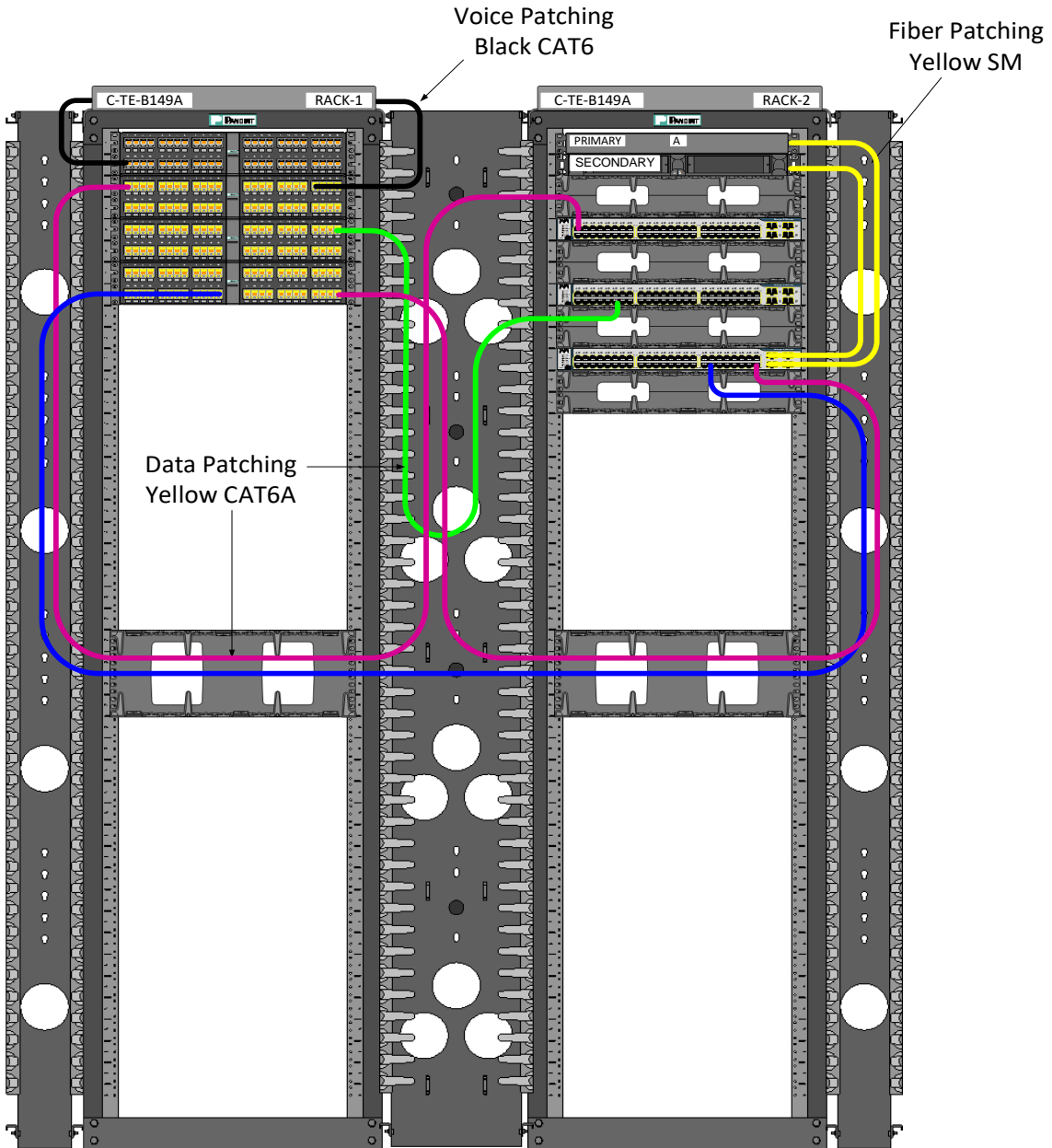

- Yellow CAT6A 7 ft patch cords —
- Yellow CAT6A 12 ft patch cords —
- Yellow CAT6A 14 ft patch cords —
- Yellow CAT6A 18 ft patch cords —
- Yellow CAT6A 20 ft patch cords —

Three Rack Patching



- Yellow CAT6A 7 ft patch cords —
- Yellow CAT6A 12 ft patch cords —
- Yellow CAT6A 14 ft patch cords —
- Yellow CAT6A 18 ft patch cords —
- Yellow CAT6A 20 ft patch cords —

Two Rack Patching

	Version: 2.9	
	Date: 05/2016	
Official Documentation: Cabling Standards		

Grounding

The TMGB, TGB, TBB, GE, all grounding and bonding of building backbone per ANSI J-STD-607 will be furnished and installed by a Division 26 Contractor. All metal infrastructures within a communications space will be grounded and bonded by a Division 27 Contractor. All telecommunication rooms will adhere to the grounding guidelines set forth in TIA/EIA-607 (Commercial Building Grounding and Bonding Requirements for Telecommunications) plus any applicable codes in Articles 250 – (Grounding) and 800 – (Communications Systems) of the NEC. For an explanation of what constitutes a proper ground point for the Telecommunications Grounding Bar (TGB) to which the equipment will be grounded, see *NEC Article 800-40*. These ground points must meet all the detailed requirements of the above mentioned *TIA/EIA-607 (Commercial Building Grounding And Bonding Requirements For Telecommunications)* as well as any additional codes in Articles (250 – *Grounding*) and (800 - *Communications Systems*) of the NEC.

A Telecommunication Grounding Bus bar (TGB) will be located in each TR. The TGB will be grounded/earthed to the Telecommunication Main Grounding Bus Bar (TMGB). Each rack will be grounded to the TGB via #6 AWG cable with two-hole lugs on each end of the grounding cable. Each grounding cable will have a machine generated label at each end (Rack-1, Rack-2, Ladder Rack.....). If building steel is present in the room, it will be grounded to the TGB also. If metal ladder rack, basket tray, or fire stop pathways are used, they will be grounded to the TGB. ALL Grounding bars and connection points will be tested for continuity and impedance. The maximum allowable impedance will be .250 ohms with respect to true ground. Grounding wire will not be coiled.

Grounding Basket Tray

The basket tray will be grounded with a minimum of 6 AWG green stranded wire. The ground wire will run along the outside of the cable tray and ground to the masked off area (or area where the paint is removed) by a Grounding Split Bolt (Ground Bolt). All Basket Tray will be grounded to the TGB in the TR and at other end to building steel (or other suitable ground). All ground wire will be secured to the outside of the basket with yellow plenum cable ties. All solid bottom inserts will be grounded to each section of the basket tray (remove paint finish where bottom insert bolts to basket tray and apply Joint Compound to grounding surfaces).

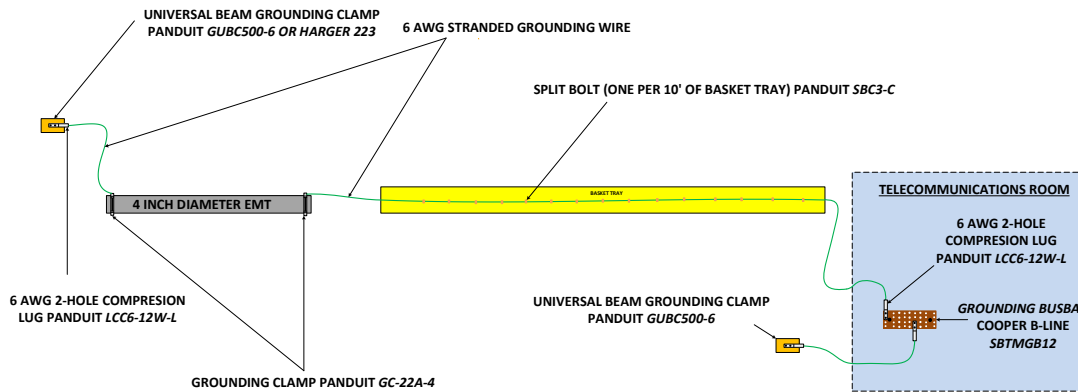

TYPICAL GROUNDING INFRASTRUCTURE FOR HORIZONTAL CABLE SUPPORTING INFRASTRUCTURE



NOTE: ALL GROUNDING CONTACT POINTS WILL BE CLEANED DOWN TO BARE METAL AND PROTECTED WITH ANTIOXIDANT

Pathways (INDOOR)

The standard for horizontal cabling will be basket tray supported by a center/trapeze hanger with 3/8 inch threaded rod. The threaded rod will be center hung spaced no more than 4ft. apart for a 12 inch tray and trapeze hung 4ft. apart for an 18 inch tray. The basket tray for the CRAA voice and data network will be yellow powder coated. The yellow colored cable tray is reserved for the exclusive use of CRAA voice and data network. The basket tray will be 12 inches or 18 inches wide. The height of the tray sides will be 4 inches high. Each basket tray will have a masked off area exposing bare metal for grounding. All basket trays will have a gradual transition in elevation not to exceed 15°. Use sweeping 90° turns or gradual horizontal

	Version: 2.9	
	Date: 05/2016	
Official Documentation:	Cabling Standards	

transitions when possible. All cut basket tray will have sharp edges filed. The pathways that have J-hooks only will be spaced four feet apart. All pathways will have self-supporting hardware that attaches directly to the building's structure. All newly installed pathways will allow for 60% cable growth. All non-data pathways will be supported by orange J-hooks and maintain a 12 inch separation from the data pathways (unless separated by grounded shielding). The orange colored J-hooks are reserved for the exclusive use of CRAA non-data low voltage cabling (everything traveling to the CRAA TR except Cat6A & SM fiber). The J-hooks for the CRAA voice and data network will be yellow powder coated (CRAA Cat6A & SM fiber). The yellow colored J-hooks are reserved for the exclusive use of CRAA voice and data network. Fiber cannot share the same yellow J-hook as Cat6A; however, fiber can share the same basket tray if it is in inner duct or armored fiber cable is used. All fiber in basket tray will be dressed separately from Cat6A (dressed to one side only and not intertwined or crossing Cat6A cable or other fiber).

See CRAA Cabling Elements Document for approved pathway assemblies.

The total cables allowed in Basket Tray and J-hooks based on NEC allowable fill is 50%.

FT4X12X10YL (4 in x 12 in) Basket Tray

$$\text{Area of Cat 6A cable} = \pi (D/2)^2 = \pi (.310 \text{ in}/2)^2 = .0755 \text{ in}^2 / \text{cable}$$

$$\text{Actual area of the tray} = 47.5 \text{ in}^2$$

$$\text{Allowable fill 100\%} = [(.50) 47.5 \text{ in}^2] / .0755 \text{ in}^2 / \text{cable} = 314$$

$$\text{Fill for new installs 40\%} = (.40)314 \text{ cables} = 125$$

FT4X18X10YL (4 in x 18 in) Basket Tray

$$\text{Area of Cat 6A cable} = .0755 \text{ in}^2 / \text{cable}$$

$$\text{Actual area of the tray} = 71.5 \text{ in}^2$$

$$\text{Allowable fill 100\%} = [(.50) 71.5 \text{ in}^2] / .0755 \text{ in}^2 / \text{cable} = 473$$

$$\text{Fill for new installs 40\%} = (.40)473 \text{ cables} = 189$$

BCH32 (2 INCH) J-HOOKS at 100% = 50 cables
 BCH32 (2 INCH) J-HOOKS at 40% = 20 cables

BCH64 (4 INCH) J-HOOKS at 100% = 200 cables
 BCH64 (4 INCH) J-HOOKS at 40% = 80 cables

CAT200CM (8 INCH) U-HOOKS at 100% = 307 cables
 CAT200CM (8 INCH) U-HOOKS at 40% = 123 cables

CAT300CM (12 INCH) U-HOOKS at 100% = 464 cables
 CAT300CM (12 INCH) U-HOOKS at 40% = 185 cables

Horizontal Conduit Pathways & Sleeves (Copper)

All horizontal conduits shall be grounded at both ends (sleeves over 3 ft. long) and maintain continuity the entire length of pathway. All new conduit pathways shall be designed not to exceed 40% of the allowable fill (100%). All conduits penetrating any wall shall have fire-barrier caulk around the conduit on both sides of the wall, or the sealer will be an equivalent material maintaining the fire rating (for a fire/smoke wall).

- 4 inch diameter conduit 100% fill = 78 Cat6A cables (40% = 31 cables)
- 3.5 inch diameter conduit 100% fill = 61 Cat6A cables (40% = 24 cables)
- 3 inch diameter conduit 100% fill = 47 Cat6A cables (40% = 19 cables)
- 2.5 inch diameter conduit 100% fill = 31 Cat6A cables (40% = 12 cables)
- 2 inch diameter conduit 100% fill = 17 Cat6A cables (40% = 7 cables)
- 1.5 inch diameter conduit 100% fill = 10 Cat6A cables (40% = 4 cables)
- 1.25 inch diameter conduit 100% fill = 8 Cat6A cables (40% = 3 cables)
- 1 inch diameter conduit 100% fill = 4 Cat6A cables (40% = 2 cables)

Fire Rated Horizontal Pathways

All pathways penetrating any fire walls (or walls that extend from floor to decking) will have a minimum fire rating equal to the penetrated wall. All pathways that pass through any wall (regardless if is a fire rated wall) shall use a fire rated pathway to provide protection of the cables and additional fire protection. Fire Rated Pathways for the CRAA voice and data network will be yellow and is reserved for that exclusive use only. All other pathways will use orange. See [Appendix B](#) for details.

Fire Rated Riser Pathways

All floor penetrations will have a minimum of three hour fire rating. If the floor fire rating is greater than three hours, then the fire rated penetration must match the floor rating. CRAA voice data network risers will be Yellow and is reserved for that exclusive use only. If there is a bank of risers, it is the responsibility of the installer using that bank to properly fire stop all penetrations. Orange pathways will be used when CRAA voice and data cables have to occupy the same riser sleeve with other cables. If the riser cannot use a self-sealing pathway, then a proper fire stopping method must be selected from the approved manufacturer listed. All risers requiring fire stopping will use a non-hardening product (Fire Stop Putty) or pillows as specified by the manufacturer to obtain proper fire rating. The selected manufacturer's fire stopping method and specifications (when the standard self-sealing device can't be used) must be provided with the Pre-Installation Submittals. All riser conduits will be rigid and those longer than 3 ft. will be grounded at both ends. See [Appendix B](#) for details.

Cable Entry

A raceway device needs to be designed to allow cables to penetrate fire-rated walls and floors without the need for fire stopping. This device will feature a built-in fire and smoke sealing system that automatically adjusts to the amount of cable installed. Once installed in a fire barrier, cables can be easily added or removed at any time without the need to remove or reinstall fire stopping materials.

A Fire Rated Pathway is needed that consists of an enclosed heavy gauge galvanized steel raceway lined with intumescent material engineered for rapid expansion when exposed to fire or high temperatures, quickly sealing the pathway and preventing the passage of flames and smoke. The pathway will have a three hour or four hour fire rating.

All self-sealing Fire Rated Pathways will be painted yellow (for CRAA voice and data exclusively) or orange (for general use) for easy identification. The pathway will have a compact square profile that allows a maximum number of cables to be installed in a relatively small area. The pathway will be approximately three inches by three inches. Six units for the horizontal TR Pathway will be installed side by side in two mounting brackets (3 gang) to form an eighteen inch by three inch opening. See [Appendix B](#) for details.

Total number of indoor Cat 6A cables to be installed in an EZDP33 is 55.

Data Center & Parts

Racks

The standard rack installed in the data center will be a four post 96 inches tall by 3 feet deep. The top of the rack will have installed a top trough with waterfall. A vertical 12 inch wire manager will be installed between each rack. Each rack will require 3/8 inch spacers to be installed between the vertical wire managers and the 4 post racks. Two 4U horizontal wire managers will be installed in each rack (one at mid-point and one at the bottom of the rack-see illustration below). The copper Cat6A racks will be separated from the fiber racks by equipment rack/racks. There will be one or more racks devoted to data center fiber optics. There will be one or more racks devoted to campus fiber. The original design will allow for 60% growth.

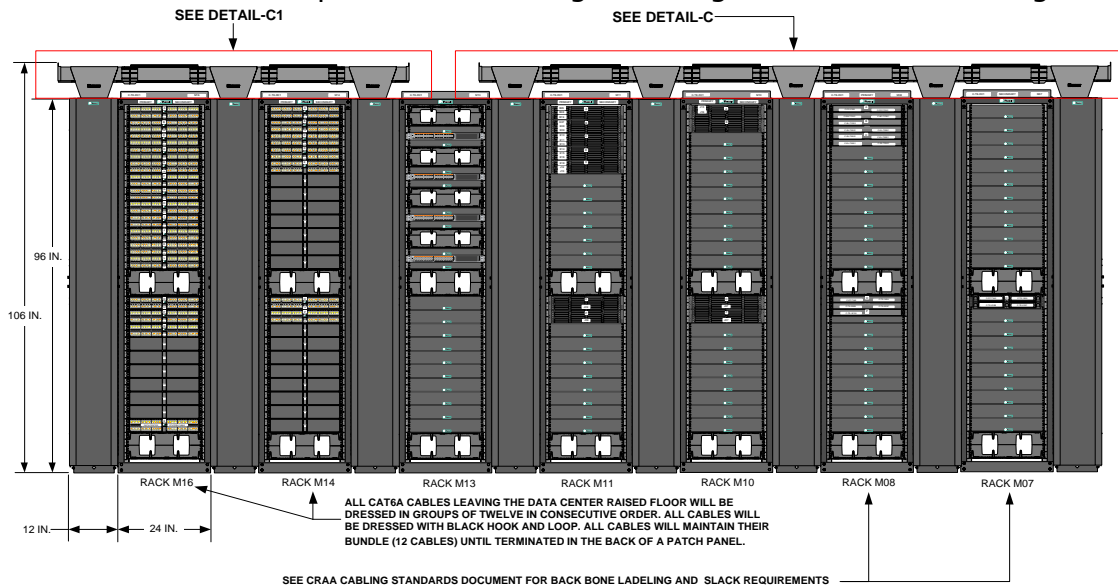

Data Center Main Cross connect Example (Elevation)

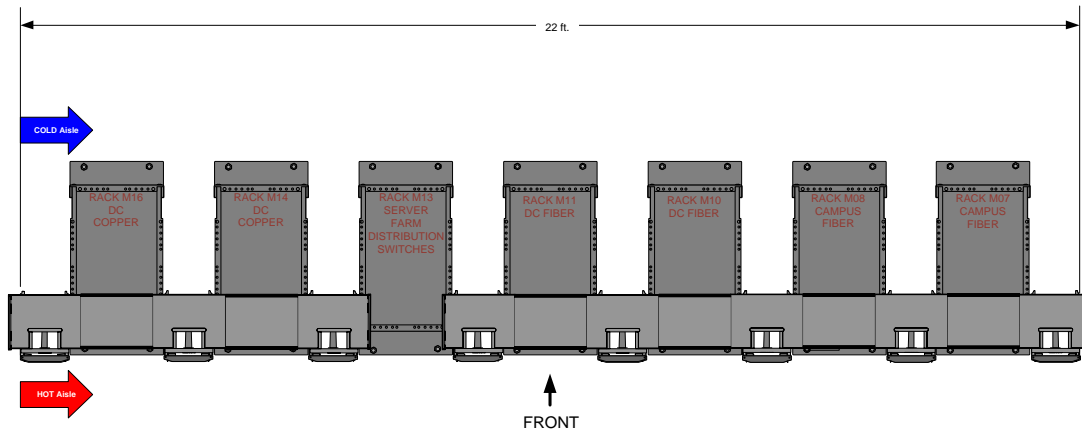

Data Center Main Cross connect Example (Top View)

Approved Rack Parts:

RACK M07 & M08 (Campus Fiber)



ITEM	QTY.	PART NO.	DESCRIPTION
1	1	R4P3696 (Panduit)	4 POST RACK (36 Inches Deep X 8 FT)
2	1	PRV1296 (Panduit)	VERTICAL WIRE MANAGER (12 Inches)
3	2	PRD1296 (Panduit)	VERTICAL WIRE MNGR DR (12 Inches)
4	?	DPFP2 (Panduit)	2U BLANK PANEL
5	2	NMF4 (Panduit)	4U HORIZONTAL WIRE MANAGER
6	?	CCH-02U (Corning)	2U LIU
7	?	CCH-CS12-A9-P00RE (Corning)	PIGTAILED CASSETTE
8	1	RGS134-1Y (Panduit)	GROUNDING STRIP KIT
9	1	GJS696U (Panduit)	6AWG GROUNDING JUMPER (96 Inches)
10	1	SBQC1/0-X (Panduit)	SPLIT BOLT QUAD CLAMP
11	1	R4PWF (Panduit)	TOP TROUGH WITH WATERFALL
12			

RACK M10 & M11 (Data Center Fiber)

ITEM	QTY.	PART NO.	DESCRIPTION
1	1	R4P3696 (Panduit)	4 POST RACK (36 Inches Deep X 8 FT)
2	1	PRV1296 (Panduit)	VERTICAL WIRE MANAGER (12 Inches)
3	2	PRD1296 (Panduit)	VERTICAL WIRE MNGR DR (12 Inches)
4	?	DPFP2 (Panduit)	2U BLANK PANEL
5	2	NMF4 (Panduit)	4U HORIZONTAL WIRE MANAGER
6	?	EDGE-02U(Corning)	2U Pretium EDGE Housing
7	1	RGS134-1Y (Panduit)	GROUNDING STRIP KIT
8	1	GJS696U (Panduit)	6AWG GROUNDING JUMPER (96 Inches)
9	1	SBQC1/0-X (Panduit)	SPLIT BOLT QUAD CLAMP
10	1	R4PWF (Panduit)	TOP TROUGH WITH WATERFALL
11			
12			

RACK M13 (Data Center Copper Cat6A)

ITEM	QTY.	PART NO.	DESCRIPTION
1	1	R4P3696 (Panduit)	4 POST RACK (36 Inches Deep X 8 FT)
2	1	PRV1296 (Panduit)	VERTICAL WIRE MANAGER (12 Inches)
3	2	PRD1296 (Panduit)	VERTICAL WIRE MANAGER DOOR (12 Inches)
4	?	DPFP2 (Panduit)	2U BLANK PANEL
5	?	DPFP1 (Panduit)	1U BLANK PANEL
6	?	NMF3 (Panduit)	3U HORIZONTAL WIRE MANAGER
7	?	NMF4 (Panduit)	4U HORIZONTAL WIRE MANAGER
8	1	R4PWF (Panduit)	TOP TROUGH WITH WATERFALL
9	4	RGEJ636PFY(Panduit)	RACK GROUNDING EQUIPMENT JUMPER
10	1	GJS696U (Panduit)	6AWG GROUNDING JUMPER (96 Inches)
11	1	SBQC1/0-X (Panduit)	SPLIT BOLT QUAD CLAMP
12	2	RCXW308-103PN6TL21-D-LP(GEIST)	VERTICAL PDU

	Version: 2.9	
	Date: 05/2016	
Official Documentation: Cabling Standards		

RACK M14 & M16

ITEM	QTY.	PART NO.	DESCRIPTION
1	1	R4P3696 (Panduit)	4 POST RACK (36 Inches Deep X 8 FT)
2	1	PRV1296 (Panduit)	VERTICAL WIRE MANAGER (12 Inches)
3	2	PRD1296 (Panduit)	VERTICAL WIRE MANAGER DOOR (12 Inches)
4	?	CPAF2BLY (Panduit)	2U ANGLED BLANK PANEL
5	2	NMF4 (Panduit)	4U HORIZONTAL WIRE MANAGER
6	7	CPPA48FMWBLY (Panduit)	48 PORT ANGLED PATCH PANAL
7	1	R4PWF (Panduit)	TOP TROUGH WITH WATERFALL
8	1	GJS696U (Panduit)	6AWG GROUNDING JUMPER (96 Inches)
9	1	SBQC1/0-X (Panduit)	SPLIT BOLT QUAD CLAMP
10			
11			
12			



Cable Tray for Racks

Attached to the top trough will be a horizontal 12 inch wide cable tray with vertical drop outs at each vertical wire manager. The horizontal copper cable tray will not connect to the horizontal fiber cable tray.

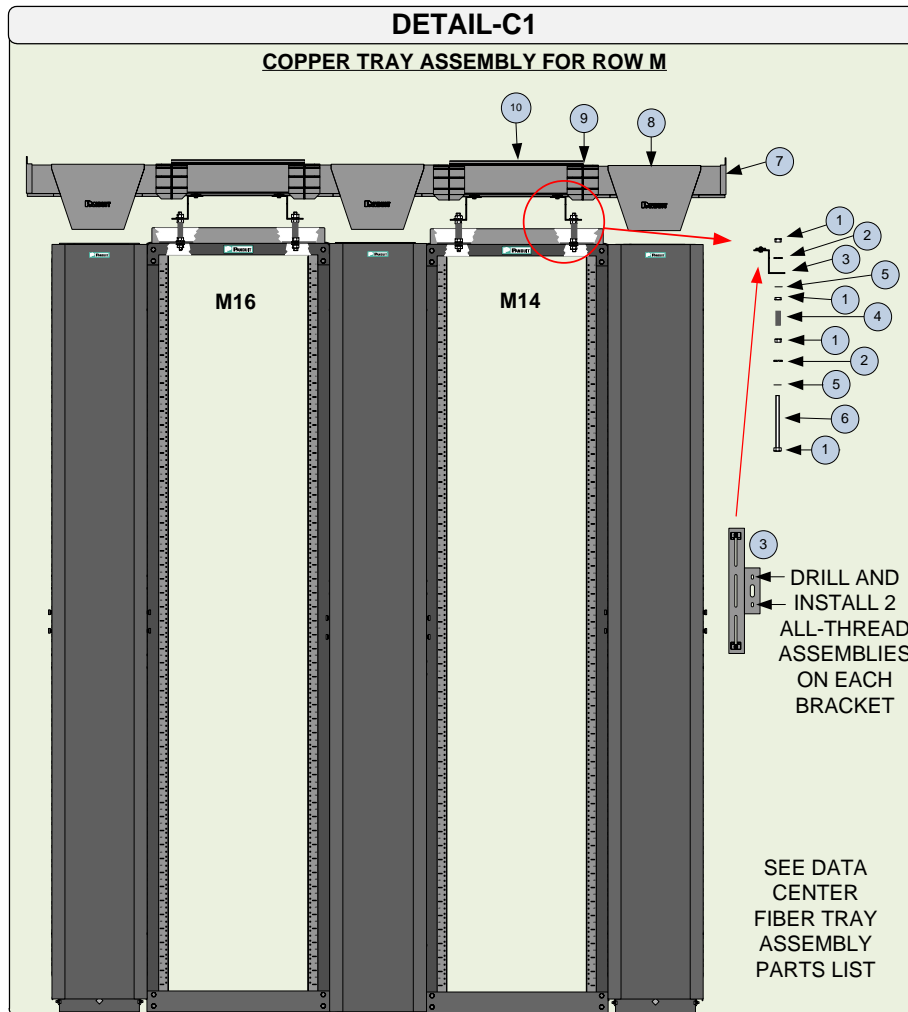

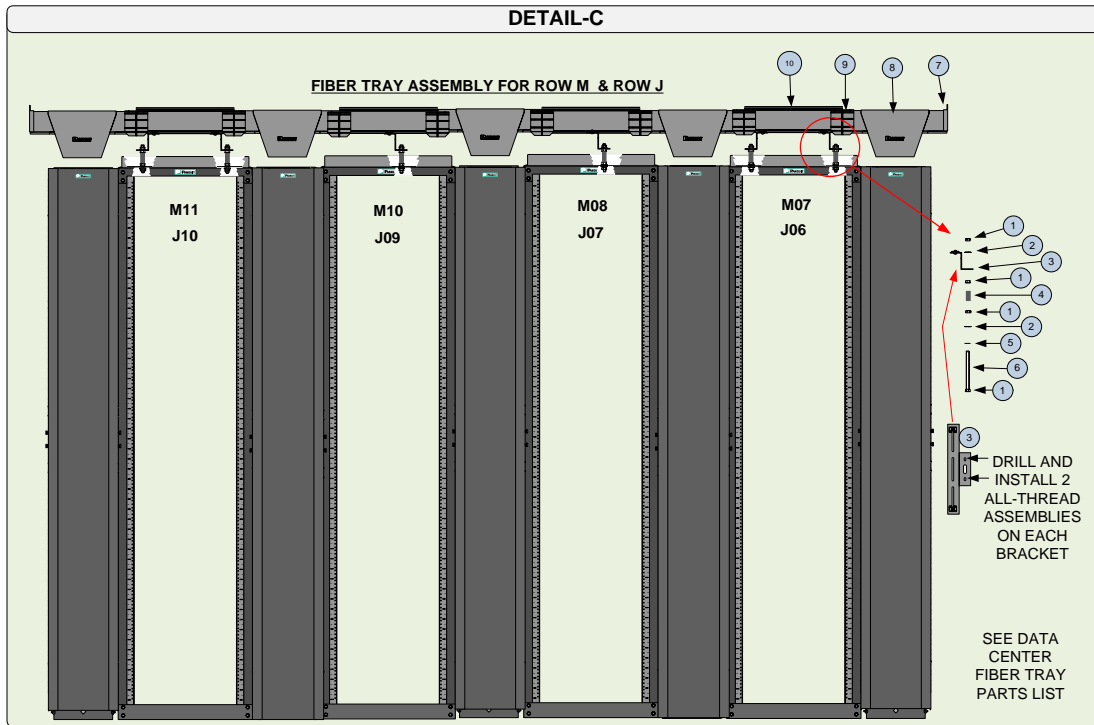

PARTS FOR DATA CENTER COPPER & FIBER TRAY

ITEM	QTY.	PART NO.	DESCRIPTION
1	?	1/2HNSB (COOPER B-LINE)	1/2 - 13 INCH HEX NUT
2	?	1/2 LWSB (COOPER B-LINE)	1/2 LOCK WASHER
3	?	FR12CS12 (Panduit)	CENTER SUPPORT BRACKET
4	?	TRC18FR-X8Y(Panduit)	THREADED ROD COVER
5	?	1/2FWSB (COOPER B-LINE)	1/2 - FLAT WASHER
6	?	ATR1/2x120YZN (COOPER B-LINE)	1/2 - ALL THREADED DROP ROD (1/2 - 13)
7	?	FREC12X4BL(Panduit)	END CAP FITTING
8	?	FRVT12X4BL (Panduit)	VERTICAL TEE
9	?	FRBC12X4BL (Panduit)	COUPLER
10	?	FR12X4BL6 (Panduit)	12 x 4 CHANNEL

It is preferred that a raised floor is used in the data center a minimum 2 Feet high. All racks will be secured to the Data Center raised floor using 1/2 inch all thread. The all thread will be anchored to the sub-floor and bolted down such that there is no added down force on the raised floor (see below illustration) down force on the raised floor (see below illustration).

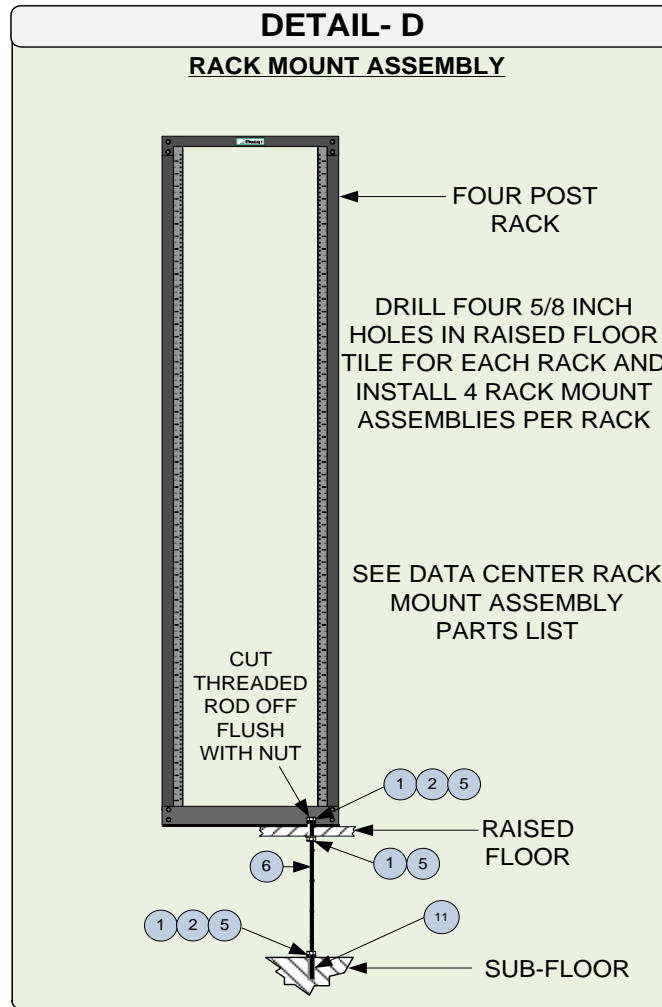

PARTS FOR DATA CENTER RACK MOUNT ASSEMBLYS

ITEM	QTY.	PART NO.	DESCRIPTION
1	?	1/2HNSB (COOPER B-LINE)	1/2 - 13 INCH HEX NUT
2	?	1/2 LWSB (COOPER B-LINE)	1/2 LOCK WASHER
5	?	1/2FWSB (COOPER B-LINE)	1/2 - FLAT WASHER
6	?	ATR1/2x120YZN (COOPER B-LINE)	1/2 - ALL THREADED DROP ROD (1/2 - 13)
11	?	ADI-50 (COOPER B-LINE)	DROP-IN ANCHOR



Cabinets

The standard cabinet will have 48 U's of rack space. The cabinet will be 83.62 inches high by 29.53 inches wide by 47.24 inches deep. Each cabinet will have 24 primary and 24 secondary Cat6A copper cables installed. Each cabinet will have 12 strand primary & 12 strand secondary OM3 multimode fiber installed. Each cabinet will have 12 strand primary single mode fiber installed. See illustrations below for U location and labeling.

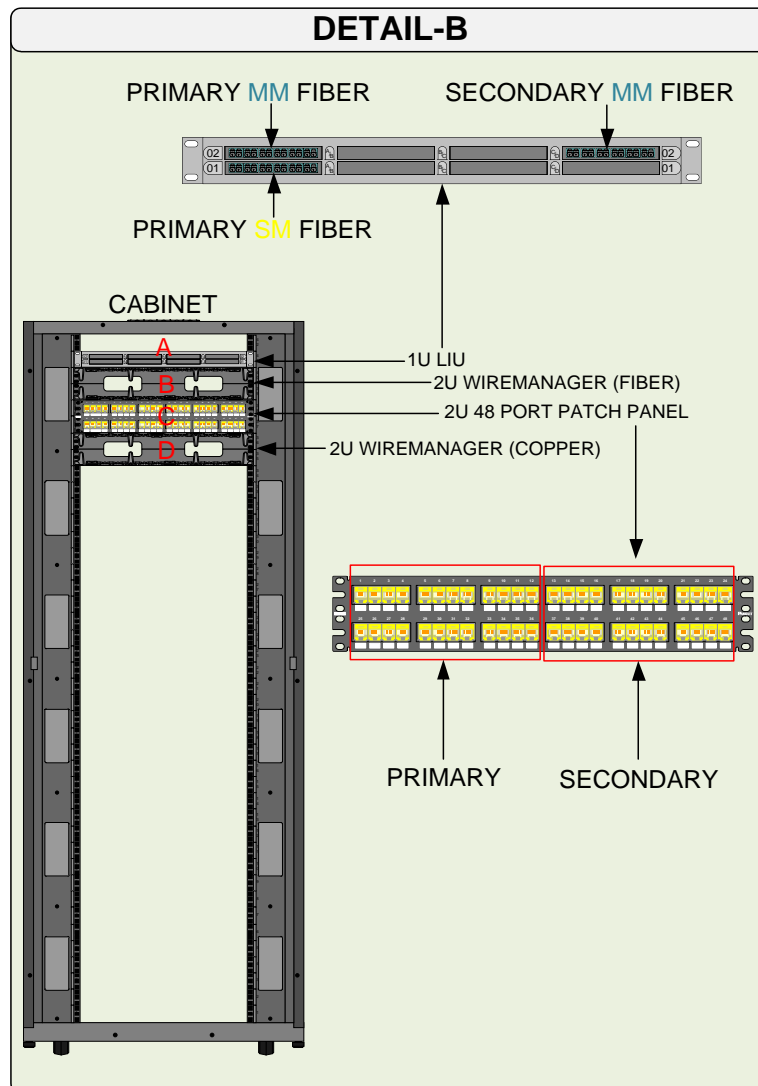

CABINET

ITEM	QTY.	PART NO.	DESCRIPTION
1	?	G757512TPNDDU??F(Corning)	Pretium EDGE Solutions Trunk (12 Strand MM)
2	?	G757512TPNDDU??F(Corning)	Pretium EDGE Solutions Trunk (12 Strand MM)
3	?	ECM-UM12-05-93T	Pretium EDGE Solution Modules (MM)
4	?	G909012GPNDU??F(Corning)	Pretium EDGE Solutions Trunk (12 Strand SM)
5	?	ECM-UM12-04-89G	Pretium EDGE Solution Modules (SM)
6	1	EDGE-01U(Corning)	1U Pretium EDGE Housing
7	2	NM2(Panduit)	HORIZONTAL WIRE MANAGER 2U
8	1	CPP48FMWPLY(Panduit)	48 PORT FLAT PATCH PANEL
9	?	CJ6X88TGYL(Panduit)	Cat6A YELLOW JACKS
10	?	PUP6A04YL-UG(Panduit)	Cat6A YELLOW CAT6A CABLE
11	1	AME-AR3357(APC)	NETSHELTER SX 48U (cabinet)
12	6	AR8442(APC)	VERTICAL WIRE MANAGER
13	2	RCXW308-103PN6TL21-D-LP(GEIST)	VERTICAL PDU



Data Center Labeling

See below for rack U labeling of data center racks and cabinets (DETAIL-B1). Also, see below fiber labeling of fiber within the Data Center (DETAIL-A). Refer to the TR labeling guidelines for all other labeling not listed.

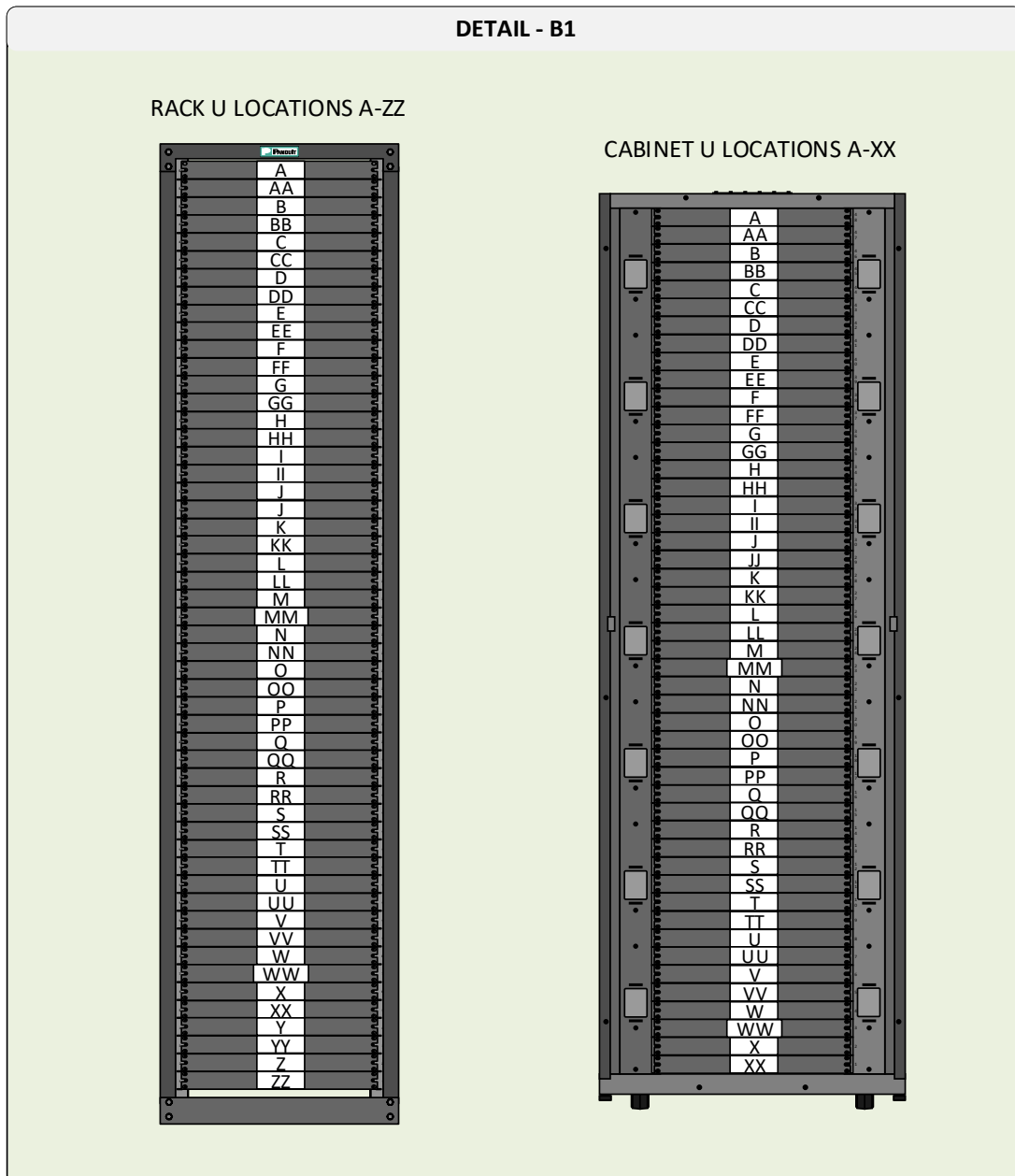



DETAIL-A

DATA CENTER FIBER TRUNK LABELING

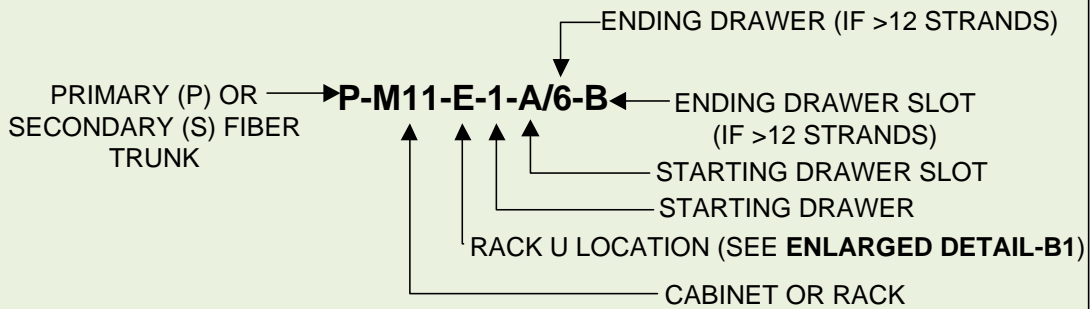

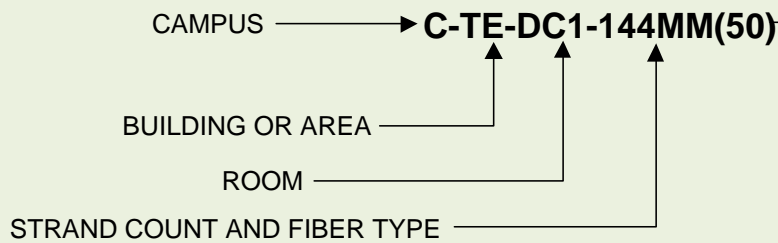
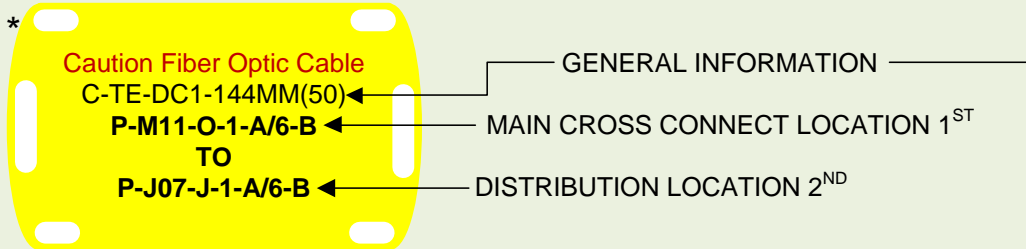

- **PRIMARY (P)** FIBER TRUNKS USE DRAW SLOTS **A & B**
- **SECONDARY (S)** FIBER TRUNKS USE DRAW SLOTS **C & D**



* Labels (yellow)-Panduit PST-FOBLNK
Cable Ties (yellow)-Panduit PLT2S-C4Y

Glossary of Terms

Term	Description
Basic Link	The Basic Link test is only for the horizontal wiring, without the patch cores. Used when the circuit is being tested by the LanMeter to certify that it meets CAT 5e/6 A specifications.
Channel	The Channel includes the user's patch cord & the TC patch cords that connect the circuit to the network electronics. You should see network traffic on this circuit if it is properly working.
NEC	The abbreviation for National Electric Code, NEC is an international standard recognized by the National Fire Protection Association. NEC practices must be adhered to on any electrical installation, including those involving low voltage.
OSP	The abbreviation for Out-Side-Plant refers to any cable or work performed between CRAA buildings, or work performed off CRAA property. The construction of these products, which must withstand the elements, is usually unsuitable for indoor use.
OTDR	The abbreviation for Optical Time Domain Reflectometer. This device is used to show breaks and loss problems in fiber optic cable. Warning: OTDR products emit laser radiation. Use proper safety precautions to avoid permanent eye damage.
SM	Single Mode fiber 8.3 μm in size 1330nm or 1550 nm wavelengths.
TR	The abbreviation for Telecommunications Room, also called a Hub Room, MDF/IDF or Network Distribution Room. The room is the point at which cables are terminated to patch panels and connected to network electronics.
WAO	Work Area Outlet. This is the faceplate location at the user site.

 COLUMBUS REGIONAL AIRPORT AUTHORITY	Version: 2.9	
	Date: 05/2016	
Official Documentation: Cabling Standards		

Appendix A: Approved Manufactures

- [APC](#)
- [BRADY](#)
- [BROTHER](#)
- [CADDY](#)
- [CODE BLUE](#)
- [COMPULINK/CORNING](#)
- [COOPER B-LINE](#)
- [COOPER CROUSE-HINDS](#)
- [CORNING](#)
- [GEIST](#)
- [HARGER](#)
- [HOFFMAN/PENTAIR](#)
- [HUBBELL](#)
- [ITW LINX](#)
- [L-COM](#)
- [MAXCELL](#)
- [MIDDLE ATLANTIC](#)
- [PANDUIT](#)
- [SIEMON](#)
- [STI](#)
- [SUPERIOR ESSEX](#)

Appendix B: Acceptable Materials List

CRAA Approved Parts

All parts listed in this appendix are CRAA approved.

APC

Cabinet and Wire Manager

Part Number	Description	Color/Material/Size
AME-AR3357	NetShelter SX 48U Cabinet with Sides	Black
AR8442	Vertical Wire Manager	Black

BRADY

Label Tape

Part Number	Description	Color/Material/Size
PTL-32-427	TLS2200/TLS PC Link labels (White Wrap Around Labels)	White/Translucent
R4310	TLS2200/TLS PC Link Printer Ribbon - Black (Use with Wrap Around labels)	Black
PTL-43-439-YL	TLS2200/TLS PC Link Labels (Yellow for Pull Boxes and TCs)	Yellow
R6010	TLS2200/TLS PC Link Printer Ribbon - Black (Use with Yellow Labels for Pull Boxes and TCs)	Black

BROTHER



Label Tape

Part Number	Description	Color/Material/Size
TZe-S211	6MM Black on White Tape Cassette (Extra Strength Adhesive Tape)	Black on White
TZe-S231	12MM Black on White Tape Cassette (Extra Strength Adhesive Tape)	Black on White
TZe-S241	18MM Black on White Tape Cassette	Black on White

CADDY

J-Hooks

Part Number	Description	Color
CAT32HPYL	2" Yellow J-hook	Yellow
CAT32HPYLAFAB6	2" Yellow J-hook with Angle Bracket with 3/8" Hole	Yellow
CAT64HPYL	4" Yellow J-hook	Yellow
CAT64HPYLAFAB6	4" Yellow J-hook with Angle Bracket with 3/8" Hole	Yellow
CAT32HPOR	2" Orange J-hook	Orange
CAT32HPORAFAB6	2" Orange J-hook with Angle Bracket with 3/8" Hole	Orange
CAT64HPOR	4" Orange J-hook	Orange
CAT64HPORAFAB6	4" Orange J-hook with Angle Bracket with 3/8" Hole	Orange
RET32B50	Retainer Clip for 2" J-hooks	Pregalvanized
RET64B25	Retainer Clip for 4" J-hooks	Pregalvanized

	Version: 2.9	
	Date: 05/2016	
Official Documentation: Cabling Standards		

U-Hook

Part Number	Description	Color
CAT200CMLNYL	8" U-Hook	Yellow
CAT300CMLNYL	12" U-Hook	Yellow
CAT200CMYL	8" U-Hook with T-nut for Uni-Strut Mounting	Yellow
CAT300CMYL	12" U-Hook with T-nut for Uni-Strut Mounting	Yellow
CATRT200CM	9.5" Retainer Clip for 8" U-Hooks	Pregalvanized
CATRT300CM	13.5" Retainer Clip for 12" U-Hooks	Pregalvanized
CATTBCM	CM Protection Tube for Threaded Rod 4"	Electrogalvanized

CODE BLUE



Emergency Phone

Part Number	Description	Color/Material/Size
40159	LED Beacon/Strobe Kit W/Hardware	Blue
40029	POE Power Kit	
41550	Wire Strobe Conn. 114" Red Black Molded	Red/Black
IP5000	VOIP Phone	
41549	Harness Y/Y for Strobe 114"	

COMPULINK/CORNING

Horizontal Fiber



Part Number	Description	Color/Material/Size
FUMR-5D5DT-4-100M	4SM Pre-Terminated LC-LC Fiber	Yellow

	Version: 2.9	
	Date: 05/2016	
Official Documentation: Cabling Standards		

COOPER / B-LINE

Ladder Rack

Part Number	Description	Color/Material/Size
SB17U18BFB	Tubular Runway 1-1/2" x 18"	Flat Black
SB17U12BFB	Tubular Runway 1-1/2" x 12"	Flat Black
SB156ABZ	Runway Support	Black Zinc
SB2107BZ	Butt Splice Clamp Kit	Black Zinc
SB2101ABZ	90° Junction Splice Clamp Kit	Black Zinc
SB227R6FB	Standoff Kit	Flat Black
SB21318KFB	Triangle Wall Support Kit for 12" - 18"	Flat Black
SB21312KFB	Triangle Wall Support Kit for 6" - 12"	Flat Black
SB211318FB	Wall Angle Support Kit for 18"	Flat Black
SB211312FB	Wall Angle Support Kit for 12"	Flat Black
SB210509FB	Runway Termination Kit for 9"	Flat Black
SB2129SD09FB	Side Drop-Out 9"	Flat Black
SB2129SD18FB	Side Drop-Out 18"	Flat Black
SB2129U12FB	Runway Drop-Out 12"	Flat Black
SB782M12	Cable Management Spool w/Hardware (Mushroom)	Black
SB110A1B	Ladder Rack End Cap	Black
SB1003JBZ	J-Bolt 2 3/4" Long with Nut and Lock Washer	Black Zinc
SB2111ABZ	90° Runway Kit	Black Zinc
SB2111BBZ	90° Runway Turn Kit	Black Zinc
SB119EFB	Cable Supports (Ground Wire)	Flat Black
SB17DRK18FB	Rung Drop Out Kit	Flat Black
SB12610FB	10" Cable Retaining Post	Flat Black

	Version: 2.9	
	Date: 05/2016	
Official Documentation: Cabling Standards		

Flex Tray

Part Number	Description	Color/Material/Size
FT4X12X10YL	Flex Tray 4"x12"x10' Yellow (Masked for Grounding)	Yellow
FT4X18X10YL	Flex Tray 4"x18"x10' Yellow (Masked for Grounding)	Yellow
FTSWN	Flex Tray Wing Splice	Zinc
FTB12CT	Flex Tray Center Trapeze Hanger 12"	Pre-Galvanized
FTB18CT	Flex Tray Center Trapeze Hanger 18"	Pre-Galvanized

Grounding

Part Number	Description	Color/Material/Size
GROUND BOLT	Flex Tray Grounding Split Bolt	Copper Plated
SBTMGB12K	Telecommunications Main Ground Bar 12"x4" Kit (Includes Hardware)	12"x4"
SB6693/4X101/2	10 1/2" 2 Hole Grounding Strap with Mounting Hardware	Tin Plated
SBTMGB12	Telecommunications Main Ground Bar 12"x4"	12"x4"
SBTMGB20	Telecommunications Main Ground Bar 20"x4"	20"x4"
SBTGB	Grounding Bus Bar 12"x4"	12"x4"
SBJCC	Joint Compound (Copper)	

Conduit Fittings

Part Number	Description	Color/Material/Size
BL1420	1" Conduit Hanger	Zinc
BL1450	2" Conduit Hanger	Zinc
BL1470	3" Conduit Hanger	Zinc
BL1490	4" Conduit Hanger	Zinc
BPC-16	1" EMT/Rigid Uni-Strut Clamp	Zinc
BPC-20	1 ¼" EMT/Rigid Uni-Strut Clamp	Zinc
BPC-24	1 ½" EMT/Rigid Uni-Strut Clamp	Zinc
BPC-32	2" EMT/Rigid Uni-Strut Clamp	Zinc
BPC-48	3" EMT/Rigid Uni-Strut Clamp	Zinc
BPC-64	4" EMT/Rigid Uni-Strut Clamp	Zinc
B2301-1	1" EMT 1-Hole Strap	Zinc
B2301-1¼	1 ¼" EMT 1-Hole Strap	Zinc
B2301-1½	1 ½" EMT 1-Hole Strap	Zinc
B2301-2	2" EMT 1-Hole Strap	Zinc
B2302-3	3" EMT 1-Hole Strap	Zinc
B2302-4	4" EMT 1-Hole Strap	Zinc
B2302-1	1" Rigid 1-Hole Strap	Zinc
B2302-1¼	1 ¼" Rigid 1-Hole Strap	Zinc
B2302-1½	1 ½" Rigid 1-Hole Strap	Zinc
B2302-2	2" Rigid 1-Hole Strap	Zinc
B2302-3	3" Rigid 1-Hole Strap	Zinc
B2302-4	4" Rigid 1-Hole Strap	Zinc

Hardware

Part Number	Description	Color/Material/Size
B444-3/8ZN	3/8"-16 Beam Clamp	Zinc
B655-3/8	Threaded Rod Coupling 3/8" - 16	Zinc
ATB-37-300	3/8" x 3" Toggle	Zinc
SB588A	Network Equipment Rack Anchor Kit	Zinc
3/8HN	3/8" Hex Nut	Zinc
3/8LW	3/8" Lock Washer	Zinc
3/8FW	3/8" Flat Washer	Zinc
3/8X1" HHCS	3/8"X1" Hex Head Bolt	Zinc
ATR3/8X120	3/8" Threaded Rod 120"	Zinc
N228	3/8"-16 Spring Nuts	Zinc
1/4X1" HHCS	1/4"X1" Hex Head Bolt	Zinc
1/4HN	1/4" Hex Nut	Zinc
1/4LW	1/4" Lock Washer	Zinc
1/4FW	1/4" Flat Washer	Zinc
ARC-37-150	3/8" Concrete Rapid Rod hanger	Zinc
½HNSB	1/2" Hex Nut	Silicon Bronze
½LWSB	1/2" Lock Washer	Silicon Bronze
½FWSB	1/2" Flat Washer	Silicon Bronze
ATR1/2X120YZN	1/2" Threaded Rod 120"	Zinc
ADI-50	1/2" Drop-In Anchor	Zinc
B22SH	Steel Channel	Galvanized
B221½	Steel Channel	Galvanized
B2795Q	Steel Channel Post Base	Galvanized
B104SH	Steel Channel 90° Angle	Galvanized

Misc.

Part Number	Description	Color/Material/Size
BB-10L	Single Gang Wall Bracket	Pre-Galvanized
BB-20L	Double Gang Wall Bracket	Pre-Galvanized
SB749V1915SFB	2U Vented Shelf	Flat Black
4418 G NK	4"X4"X18" Wireway	Gray
44E	End Caps for 4"x4" Wireway	Gray

COOPER/CROUSE-HINDS

Outlet Boxes & Lids

Part Number	Description	Color/Material/Size
TP480	4"X4" Flat Single Gang Device ring	
TP472	4"X4" Blank Cover	
TP7134	Double Gang Deep Weatherproof Outlet Boxes (2 5/8" Deep)	Gray
TP7296	Double Gang Blank Steel Cover with Gaskets	Gray
TP484	Outlet Box Double Gang to Single Gang Reducer 5/8" Raised	
TP436	4"x4"x2 1/8" Outlet box (8-1" Knockouts)	

Conduit Fittings

Part Number	Description	Color/Material/Size
1452	1" EMT Straight Connectors	Zinc
1453	1 1/4" EMT Straight Connectors	Zinc
1454	1 1/2" EMT Straight Connectors	Zinc
1455	2" EMT Straight Connectors	Zinc
1457	3" EMT Straight Connectors	Zinc
1459	4" EMT Straight Connectors	Zinc
152	1" Rigid Straight Connectors	Iron
153	1 1/4" Rigid Straight Connectors	Iron
154	1 1/2" Rigid Straight Connectors	Iron
155	2" Rigid Straight Connectors	Iron
1457DC	3" Rigid Straight Connectors	Iron
1459DC	4" Rigid Straight Connectors	Iron
SSR13	1" Rigid Raintight Straight Connectors	Iron
SSR14	1 1/4" Rigid Raintight Straight Connectors	Iron
SSR15	1 1/2" Rigid Raintight Straight Connectors	Iron
SSR16	2" Rigid Raintight Straight Connectors	Iron
GLS10	4" Grounding Bushing	#3-#06
GLS8	3" Grounding Bushing	#1-#08





Version: 2.9

Date: 05/2016



Official Documentation: **Cabling Standards**

GLS6	2" Grounding Bushing	#4-#14
GLS5	1 1/2" Grounding Bushing	#4-#14
GLS4	1 1/4" Grounding Bushing	#4-#14
HGLS3C	1" Grounding Bushing	#4-#14
462	1" EMT Coupling	Zinc
463	1 1/4" EMT Coupling	Zinc
464	1 1/2" EMT Coupling	Zinc
465	2" EMT Coupling	Zinc
467	3" EMT Coupling	Zinc
469	4" EMT Coupling	Zinc
162	1" Rigid Coupling	Iron
163	1 1/4" Rigid Coupling	Iron
164	1 1/2" Rigid Coupling	Iron
165	2" Rigid Coupling	Iron
467	3" Rigid Coupling	Iron
469	4" Rigid Coupling	Iron
SSR23	1" Rigid Raintight Coupling	Iron
SSR24	1 1/4" Rigid Raintight Coupling	Iron
SSR25	1 1/2" Rigid Raintight Coupling	Iron
SSR26	2" Rigid Raintight Coupling	Iron
LT100	1" Liquid Tight Straight Connector	Iron
LT125	1 1/4" Liquid Tight Straight Connector	Iron
LT150	1 1/2" Liquid Tight Straight Connector	Iron
LT200	2" Liquid Tight Straight Connector	Iron
LT250	2 1/2" Liquid Tight Straight Connector	Iron
LT300	3" Liquid Tight Straight Connector	Iron
497 3	1" EMT 2-Hole Strap	Zinc
497 4	1 ¼" EMT 2-Hole Strap	Zinc
497 5	1 ½" EMT 2-Hole Strap	Zinc
497 6	2" EMT 2-Hole Strap	Zinc
496 10	3" EMT 2-Hole Strap	Zinc
496 12	4" EMT 2-Hole Strap	Zinc

	Version: 2.9	
	Date: 05/2016	
Official Documentation: Cabling Standards		

CORNING

Indoor/Outdoor Pre-terminated (AnyLan™ Riser Rated)

Part Number	Description	Color/Length
M1M112EBZD1X□□□F-P	12SM OptiTip HARNESS ASSEMBLY MT(FM) - MT(FM) OS2	4300' MAX
M20212EBZD1X□□□F-P	12SM OptiTip HARNESS ASSEMBLY MT(MALE) - LC OS2	4300' MAX
CC1-240TR-24A9H	1U HOUSING 24SM OptiTip ADAPTERS MT - LC	Black



AnyLan Selection Guide

OptiTip Connector Code Description

Connector Code	Description	Note
M1	SM Non-Pinned (Female)	* OptiTip mating requires a non-pinned (female) to pinned (male) connection * Non-pinned(female) OptiTip connector utilizes a pulling eye
M2	SM Pinned (Male)	
M3	MM Non-Pinned (Female)	
M4	MM Pinned (Male)	

OptiTip Pinning Configuration

	Standard OptiTip Configuration	Optional Configuration
Direct Trunk	Non-Pinned (Female) to Non-Pinned (Female)	NA
Extender Trunk	Non-Pinned (Female) to Pinned (Male)	NA
OptiTip Harness Assembly	Pinned (Male) to LC, SC or ST single-fiber connectors	Non-Pinned (Female) to LC, SC or ST single-fiber connectors
Zeux Panel Assembly	Pinned (Male) to LC, SC or ST single-fiber adapter panels	Non-Pinned (Female) to LC, SC or ST single-fiber adapter panels

	Version: 2.9	
	Date: 05/2016	
Official Documentation: Cabling Standards		

Integrated Single-Panel Housing	Pinned (Male) to LC, SC or ST single-fiber adapter panels	NA
Integrated 1U Housing	Pinned (Male) to LC, SC or ST single-fiber adapter panels	NA

Indoor (Armored Plenum)

Part Number	Description	Color/Length
012E88-33131-A3	12SM ARMORED MIC PLENUM FIBER OS2	Yellow
024E88-33131-A3	24SM ARMORED MIC PLENUM FIBER OS3	Yellow

Indoor/Outdoor (Freedom® & LST™ Loose Tube Riser Rated)

Part Number	Description	Color/Length
□□□EUF-T4101D20	SM OS2 FREEDOM® LOOSE TUBE GEL-FREE CABLE (STANDARD) 11.7" B.R.	Black
□□□ESF-T4101D20	SM OS2 FREEDOM® LST™ LOOSE TUBE GEL-FREE CABLE (TIGHT BEND) 4.4" B.R.	Black

□□□ = Fiber Count (012, 024, 048, 072, 096, 144, 196, 288)
 Installation Temperature = 14°F to 144°F

Outdoor (Altose® Loose Tube)

Part Number	Description	Color/Length
□□□EU4-T4101D20	SM OS2 Altose® LOOSE TUBE GEL-FREE CABLE	Black

Limited to outdoor applications only. Consult CRAA rep. for approval.

Fiber Connector Housing & Adapter Panels & Splice Protectors

Part Number	Description	Color/Length
CCH-02U	2U Fiber Housing	Black
CCH-01U	1U Fiber Housing	Black
CCH-CS12-A9-P00RE	CCH Pigtail Cassette 12SM LC UPC OS2	
CCH-CS12-A9	CCH Duplex LC UPC 12 SM Adapter Panel	Blue/Black
2806031-01	Splice Protectors	Clear

Pretium Edge Solutions

Part Number	Description	Color/Length
G757512TPNDDU??F	Pretium EDGE Solutions Trunk Cable (12 Strand MM)	
ECM-UM12-05-93T	Pretium EDGE Solutions Modules (MM)	Aqua/Aqua
G909012GPNDDU??F	Pretium EDGE Solutions Trunk Cable (12 Strand SM)	
ECM-UM12-04-89G	Pretium EDGE Solutions Modules (SM)	Blue/Black
EDGE-01U	1U Pretium EDGE Housing	Silver
EDGE-02U	2U Pretium EDGE Housing	Silver

Armored Cable Grounding Kit

Part Number	Description	Color/Length
FDC-CABLE-GRND	Armored Cable Grounding Kit	

Patch Cords

Part Number	Description	Color/Length
040402G5120001M	SM 1 Meter LC-LC	Yellow
040402G5120002M	SM 2 Meter LC-LC	Yellow
040402G5120003M	SM 3 Meter LC-LC	Yellow
040402G5120004M	SM 4 Meter LC-LC	Yellow
040402G5120005M	SM 5 Meter LC-LC	Yellow
040402G5120006M	SM 6 Meter LC-LC	Yellow
040402G5120007M	SM 7 Meter LC-LC	Yellow
040402G5120008M	SM 8 Meter LC-LC	Yellow
040402G5120009M	SM 9 Meter LC-LC	Yellow
040402G5120010M	SM 10 Meter LC-LC	Yellow
050502T582001M	MM 50 µm 1 Meter LC-LC	Aqua
050502T582002M	MM 50 µm 2 Meter LC-LC	Aqua
050502T582003M	MM 50 µm 3 Meter LC-LC	Aqua
050502T582004M	MM 50 µm 4 Meter LC-LC	Aqua
050502T582005M	MM 50 µm 5 Meter LC-LC	Aqua
050502T582006M	MM 50 µm 6 Meter LC-LC	Aqua

Generic Specifications (Hyperlinks)

[AnyLan](#)
[SM Fiber in Loose Tube & Ribbon Cable](#)

GEIST

PDU

Part Number	Description	Color
RCXW308-103PN6TL21-D-LP	Vertical PDU	Black

HARGER

Grounding

Part Number	Description	Color/Material
223	Flange Bonding Clamp	Copper

HOFFMAN/PENTAIR

Cabinets and Pull Boxes

Part Number	Description	Color
ASE8X8X4	Screw Cover Type 1 Pull Box 8"x8"x4"	Gray
ASE12x12x4NK	Screw Cover Type 1 Pull Box 12"x12"x4"	Gray
DUD606030P	ULTRX WIFI, NEMA TYPE 4X Cabinet	Gray
UUHKL	Key Lock Kit	
A-HCI-5E	Vapor Corrosion Inhibitor	Red
ECL603537VP	COMLINE™ Vertical Mount Cabinet (OSP)	Gray
EPMC6	Mounting Bracket for COMLINE Vertical Mount Cabinet (OSP)	Gray
F44T118GV	Straight Section Wire Way 4"x4"x18"	Gray
533JH	Pole Mount NEMA 4 Cabinet	Gray
549JH	Pole Mount NEMA 4 Cabinet with AC	Gray
C8861	Pole Mount Cabinet Bracket	Gray

HUBBEL

Cabinet

Part Number	Description	Color
IDF32	RE-BOX® Commercial Cabinet 32"x24.2"x10" NEMA 2	Light Gray
REKZ	5U Equipment Mounting Bracket for Wall Mount Cabinets	Light Gray
REKG	Gasket Kit for RE-BOX® 10'	Black
REK19	4U Patch Panel Bracket Bottom-Hinged	Light Gray
REKH	Padlock Hasp Kit For RE-BOX®	Black

Hi-Impact Copper

Part Number	Description	Color
HI6??AA	HI-Impact CAT6 OSP 60' Patch Cord (Standard CAT6 RJ45 on Both Ends)	Black
HICH	Coupler Housing	Black
HI6??AE	HI-Impact CAT6 25' Patch Cord (Hi-Impact Connector to Standard RJ45)	Black
HI6	CAT6 Jack for Coupler Housing	Gray/Black

ITW LINX

Surge Protection

Part Number	Description	Color
ML25-CAT5-(75/235)	Cat5E Building Entrance Protection	Off White
CAT6-75	1GB CAT6 CISCO POE Surge Protection/110 Punch Down	Off White
CAT6-75-RJ45	1GB CAT6 CISCO POE Surge Protection/110 Punch Down to RJ45	Off White
CAT5-235	Analog Phone Line Protection/110 Punch Down	Off White

L-COM

Liquid Tight Cable Gland

Part Number	Description	Color
ASR-PG13	Liquid Tight Cable Gland (CABLE DIA. .236" TO .472" (6 TO 12MM))	Black
ASR-PG11	Liquid Tight Cable Gland (CABLE DIA. .118" TO .279" (3 TO 7MM))	Black

Patch Cord

Part Number	Description	Color
TRD695AHF-□□	OSP CAT6A Patch Cord (□□ = LENGTH)	

NEMA Enclosure

Part Number	Description	Color
NBV755	7x5x5 Miniature Industrial Enclosure	Gray
NB121005-KIT01	12X10X5 NEMA 4X Enclosure	Gray

MAXCELL

MaxCell

Part Number	Description	Color
MXC3456BK□□□	3" - 3 Cell Standard	White
MXD3456BK□□□	3" - 3 Cell Detectable	White
MXC4003GR□□□	4" - 3 Cell Standard	White
MXD4003GR□□□	4" - 3 Cell Detectable	White

MIDDLE ATLANTIC

Misc.

Part Number	Description	Color
VPM-4	4U Vertical Panel Mount	Black
UTR-1	1U Vented Shelf	Black

PANDUIT

Racks / Wire Management

Part Number	Description	Color
R4P36	4-Post Rack 45U	Black
R4P3696	4-Post Rack 52U (Data Center Only)	Black
PRV6	6" Vertical Wire Manager 45RU	Black
PRD6	6" Vertical Wire Manager Door 45RU	Black
PRV12	12" Vertical Wire Manager 45RU	Black
PRD12	12" Vertical Wire Manager Door 45RU	Black
PRV1296	12" Vertical Wire Manager 52RU (Data Center Only)	Black
PRD1296	12" Vertical Wire Manager Door 52RU (Data Center Only)	Black
R4PWF	Top Trough with Waterfall	Black
FR12X4BL6	12x4 FiberRunner® Channel	Black
FRBC12X4BL	12x4 FiberRunner® Channel Coupler Fitting	Black
FRVT12X4BL	12x4 FiberRunner® Channel Vertical Tee Fitting	Black
FREC12X4BL	12x4 FiberRunner® Channel End Cap Fitting	Black
FR12CS12	FiberRunner® Center Support Bracket	Black
HS2X2BL6NM	2"x2" Fiber Runner Hinged Channel	Black
HC2BL6	Hinged Fiber Runner Cover	Black
NM2	2U Horizontal Wire Manager Dual Sided	Black
NMF2	2U Horizontal Wire Manager 1-Sided	Black
NMF3	3U Horizontal Wire Manager 1-Sided	Black
NMF4	4U Horizontal Wire Manager 1-Sided	Black
SRB19MDBL	Strain Relief Bar	Black

Patch Panels / Filler Panels

Part Number	Description	Color
CPP48FMWBLY	48 Port Flat Patch Panel	Black
CPP24FMWBLY	24 Port Flat Patch Panel	Black
CPPA48FMWBLY	48 Port Angled Patch Panel	Black
CPATCBL	Angled Patch Panel Cover Plate	Black
CPAF2BLY	2U Angled Filler Panel	Black
DPPF1	1U Rack Filler Panel	Black
DPPF2	2U Rack Filler Panel	Black
DPPF4	4u Rack Filler Panel	Black

Wall Enclosure

Part Number	Description	Color
FWME4	Wall mount Enclosure	Black
FELS	Lock for Service Provider Side (CRAA)	Black
FMP6	Modular Patch Panel for Wall Enclosures	Black

Mini-Com Jacks & Fiber Adapter

Part Number	Description	Color
CJ6X88TGL	Mini-Com CAT6A	Yellow
CJE688TGIW	Mini-Com CAT6	White
CC6X88IW	Mini-Com CAT6A Coupler	White
CJ5E88TGBL	Mini-Com CAT5E Black Jacks	Black
DRJ6X88TGBL	Keystone CAT6A Black Jack	Black
CMDSLCZBU	Mini-Com LC SM Dplx Adapter	Blue

Cable

Part Number	Description	Color
PUP6A04YL-UG	Cat6A Cable	Yellow
PUP6AM04YL-UG	Shielded CAT6A Cable	Yellow

Faceplates & Surface Boxes & Raceway



Part Number	Description	Color
CBEIYW	1 Gang Face Plate Frame	Off White
CBEIW-2GY	2 Gang Face Plate Frame	Off White
CHBZIW-X	1/2 Size Blank	Off White
CHS2IW-X	1/2 Size Module 2 Jack Inserts	Off White
CMBIW-X	Blank Insert	Off White
MIWBAIW	Double Gang to Single Gang Adapter	Off White
CPNIW	Single Gang Blank Face Plate	Off White
CFPWR4CIG	1 Gang Water Resistant Face Plate	Off White
CFG4IW	1 Gang GFCI Modular Frame	Off White
CF1064IWY	1 Gang Duplex Modular Frame	Off White
UICFPRT4IW	1 Gang Tamper Resistant Face Plate	Off White
CFPWR4CIG	Gray Weather Resistant Face Plate Kit	Gray
KWPY	Keystone Wall Phone Plate	Stainless
CBX1IW-A	Single Port Surface Mount Box	Off White
CBX2IW-AY	Surface Mount Box	Off White
CBX2BL-AY	Surface Mount Box	Black
JB1DIW-A	Single Gang Deep Outlet Box	Off White
LD10IW6-A	Surface Raceway	Off White/6'
LD10IW8-A	Surface Raceway	Off White/8'
LD10IW10-A	Surface Raceway	Off White/10'
DCF10IW-X	Drop Ceiling/Entrance Fitting	Off White
CF10IW-X	Coupler Fitting	Off White
ECF10IW-X	End Cap	Off White

Grounding

Part Number	Description	Color/Material/ Length
RGS134-1Y	Grounding Strip Kit	45U
RGRB19Y	Rack Mount Bus Bar	Tin Plated
CNBK	Green Bonding Cage Nuts and Screws	Green
TRBSK	Bonding Stud Kit	Green
GUBC500-6	Universal Beam Grounding Clamp	6 AWG
LCC6-12W-L	6 AWG Two hole Compression Lug 1.75" Hole Space (Beam Clamp)	6 AWG
LCC6-38DW-L	6 AWG Two hole Compression Lug 1" Hole Space	6 AWG
GJ6□□UH	6 AWG Equipment Bonding Jumper Terminated on Both Ends	□□
GJ6120UH	6 AWG Equipment Bonding Jumper Terminated on Both Ends 120" (Rack 3)	120"
GJ696UH	6 AWG Equipment Bonding Jumper Terminated on Both Ends 96" (Rack 2)	96"
GJ672UH	6 AWG Equipment Bonding Jumper Terminated on Both Ends 72" (Rack 1)	72"
GJS696U	6 AWG Equipment Bonding Jumper Terminated on One End 96"	96"
GACBJ618U	Grounding Jumper 18" (Ladder Rack)	18"
RGEJ657PFY	Equipment Jumper	57"
RGEJ636PFY	Rack Grounding Equipment Jumper 36"	36"
P6-14R-E	Ring Terminal 6 AWG Non-Insulated 1/4" Stud	6 AWG
SBQC1/0-X	Split Bolt Quad Clamp	Bronze
GC-22A-4	4" Conduit Ground Clamp	Aluminum
GC-18A-X	2" Conduit Ground Clamp	Aluminum
HDW3/8-KT	S.S. Mounting Hardware for Bus Bar 3/8" Bolts	3/8"
HDW1/4-KT	S.S. Mounting Hardware for Bus Bar 1/4" Bolts	1/4"

Patch Cords

Part Number	Description	Color/Length
UTP6A□□YL	Yellow Cat6A Patch Cord	Yellow/□□
UTP6A1YL	1' Yellow CAT6A Patch Cord	Yellow/1'
UTP6A3YL	3' Yellow CAT6A Patch Cord	Yellow/3'
UTP6A5YL	5' Yellow CAT6A Patch Cord	Yellow/5'
UTP6A7YL	7' Yellow CAT6A Patch Cord	Yellow/7'
UTP6A9YL	9' Yellow CAT6A Patch Cord	Yellow/9'
UTP6A10YL	10' Yellow CAT6A Patch Cord	Yellow/10'
UTP6A12YL	12' Yellow CAT6A Patch Cord	Yellow/12'
UTP6A14YL	14' Yellow CAT6A Patch Cord	Yellow/14'
UTP6A18YL	18' Yellow CAT6A Patch Cord	Yellow/18'
UTP6A20YL	20' Yellow CAT6A Patch Cord	Yellow/20'
UTP6A25YL	25' Yellow CAT6A Patch Cord	Yellow/25'
STP6X12YL	12' Shielded Yellow CAT6A Patch Cord	Yellow/12'
STP6X14YL	14' Shielded Yellow CAT6A Patch Cord	Yellow/14'
STP6X18YL	18' Shielded Yellow CAT6A Patch Cord	Yellow/18'
STP6X20YL	20' Shielded Yellow CAT6A Patch Cord	Yellow/20'
STP6X25YL	25' Shielded Yellow CAT6A Patch Cord	Yellow/25'
UTP28SP□□BL	Black Cat6 Patch Cord	Black/□□
UTP28SP3BL	3' Black CAT6 Patch Cord	Black/3'
UTP28SP7BL	7' Black CAT6 Patch Cord	Black/7'
UTP28SP10BL	10' Black CAT6 Patch Cord	Black/10'
UTP28SP14BL	14' Black CAT6 Patch Cord	Black/14'
UTP28SP25BL	25' Black CAT6 Patch Cord	Black/25'

	Version: 2.9	
	Date: 05/2016	
Official Documentation: Cabling Standards		



Misc.

Part Number	Description	Color
TRC18FR-X20Y	Threaded Rod Cable Protector 18"	Black
TRC18FR-X8Y	Threaded Rod Cable Protector 18"	Gray
HLS-75R0	75' Non-Plenum Hook and Loop Roll	Black
HLSP3S-X12	12" Plenum Hook and Loop Ties	Maroon
ABMT-S6-C60	Screw mount for Hook and Loop Low Profile	Black
ABMT-S6-C69	Screw mount for Hook and Loop Low Profile	Natural
PLT2S-C4Y	7.4" Pan-Ty Cable Ties	Yellow
PLT2S-C20	7.4" Pan-Ty Cable Ties	Black
HSECFR0.5-XY	Heat Shrink Flame Retardant End Caps	Black
SE125PSC-LR0	1.25" Expandable Sleeving	Black
SE175PSC-CR0	1.75" Expandable Sleeving	Black
RFG8X8Y	Cool Boot Raised Floor Air Sealing Grommet	Blue
PST-FOBLNK	2"x3.5" Yellow Tag	Yellow

SIEMON

66-Block

Part Number	Description	Color
66M2-CAT5-(75/235)	66 Block with Patch Cord Interface	White

	Version: 2.9	
	Date: 05/2016	
Official Documentation: Cabling Standards		

STI

EZ-Path

Part Number	Description	Color
EZDP33FWS-Y	EZ-Path Series 33 Square Wall Plate Kit	Yellow
EZD33E-Y	EZ-Path Series 33 6" Yellow Modular Extension	Yellow
EZDP33FWS	EZ-Path Series 33 Square Wall Plate Kit	Orange
EZD33E	EZ-Path Series 33 6" Orange Modular Extension	Orange
EZP133W	Single Gang Attachment Plates	
EZP233W	2 Gang Attachment Plates	
EZP333W	3 Gang Attachment Plates	
EZP433W	4 Gang Attachment Plates	

Firestop Sleeve & Misc.

Part Number	Description	Color
FS100	1" Firestop Sleeve	
FS200	2" Firestop Sleeve	
RFG2	Firestop Grommet for Cable Penetration	Red
FP400	4" Firestop Plug	Pink
SSP100	Firestop Putty	Burgundy

SUPERIOR ESSEX

OSP CAT6A

Part Number	Description	Color
04-001-A5	OSP CAT6A Copper-Clad Steel 0.39" OD (1000FT)	Black
04-002-A5	OSP CAT6A Copper-Clad Steel 0.39" OD (2500FT)	Black
04-003-A5	OSP CAT6A Copper-Clad Steel 0.39" OD (5000FT)	Black
04-601-A5	OSP CAT6A Copper-Clad Steel 0.39" OD (CUT TO LENGTH)	Black
77-246-E1	OSP CAT6 CMR/CMX Outdoor Sunlight Resistant	Black

25-Pair Copper

Part Number	Description	Color
51-499-EL	CAT5E 25 PAIR OSP CM & UV Resistant .59" OD	Black
51-478-45	CAT5E 25 PAIR ISP CMR .57" OD	White

Maximum bend radius is = Cable Diameter(Cat6A) x 8

Appendix C: Data Sheets

EMI Minimum Distance Requirements for Telecommunications Pathways & Spaces

Elements	Power	Shielded Separation	Unshielded Separation
Pathways	Less Than 3 kVA	0 inches	2 inches
Cross Connect Hardware	Less Than 3 kVA	0 inches	2 inches
Pathways	3 kVA but less than 6 kVA	2 feet	5 feet
Cross Connect Hardware	3 kVA but less than 6 kVA	2 feet	10 feet
Pathways	6 kVA or greater	3 feet	10 feet
Cross Connect Hardware	6 kVA or greater	3 feet	20 feet

Note: Shielded can refer to F/UTP cable, S/FTP cable, & UTP or power cable ran in MC, BX, EMT.
General: **EMI** sources are power wires, transformers, electronic ballasts, copiers, RF sources & transmitters, large motors & generators, inductance heaters, arc welders, & X-ray equipment

INDEX



25-Pair Copper	74	CORNING	61
66-Block	72	Cubical.....	12
ADAAG.....	7	Data Center & Parts.....	38
AMAG.....	12	Cable Tray For Racks.....	43–44
ANSI.....	7	Data Center Cabinets.....	46–47
APC	52	Data Center Labeling.....	48–49
Appendix A: Approved Manufactures.....	51	Rack Mounting Assembly.....	45
Appendix B: Acceptable Materials List.....	52	Racks.....	38–42
Appendix C: Data Sheets.....	75	Disclaimer.....	2
Approved Manufacturers:.....	11	Document Control.....	79
Approved Materials:.....	11	Document Version Information.....	78
Armored Cable Grounding Kit	63	EIA/TIA.....	7
ASA.....	7	Emergency Phone	54
ASTM.....	7	EMI Minimum Distance Requirements for Telco	
Basic Link.....	50	Pathways & Spaces.....	75
BCH32.....	36	EZ-Path	73
BCH64.....	36	Faceplates & Surface Boxes & Raceway	69
BICSI.....	7	FCC.....	7
BICSI certified.....	8	Fiber Connector Housing & Adapter Panels & Splice	
BICSI Technician.....	8	Protectors	62
BOCA.....	7	Firestop Sleeve	73
BRADY	52	Flex Tray	56
BROTHER	53	Fluke DSX-5000.....	8
Cabinets and Pull Boxes	64	GE.....	33
Cable	68	GEIST	64
Cabling.....	22	Glossary of Terms.....	50
Abandoned Cable.....	24	Grounding.....	33, 56, 64, 70
Horizontal Cabling.....	22	Basket Tray Grounding.....	34
Backbone Fiber.....	22	Hardware	58
Copper Backbone.....	24	HARGER	64
Indoor Fiber Backbone.....	23	Hi-Impact Copper	65
Indoor/Outdoor Fiber Backbone Greater Than		HOFFMAN/PENTAIR	64
4300'.....	23	HUBBEL	65, 64–65
Indoor/Outdoor Fiber Backbone Less Than		IEC.....	7
4300'.....	23	IEEE.....	7
Horizontal Cabling Outdoor.....	24	Indoor (Armored Plenum)	62
CADDY	53	Indoor/Outdoor (Freedom® & LST™ Loose Tube Riser	
Channel.....	50	Rated)	62
CODE BLUE	54	Indoor/Outdoor Pre-terminated (AnyLan™ Riser	
COMPULINK/CORNING	54	Rated)	61
Conduit Fittings	57, 59	Installer Requirements.....	10
COOPER / B-LINE	55, 54–58	Corning Certified Installer (NPI).....	11
COOPER/CROUSE-HINDS	59–60	CRAA Additional Requirements.....	11

<p>Panduit Certified Installer (PCI)10</p> <p>Introduction.....6</p> <p>ITU7</p> <p>ITW LINX65</p> <p>J-hooks35</p> <p>J-Hooks53</p> <p>Key Box12</p> <p>Labeling Elements15</p> <p style="padding-left: 20px;">Labeling Face Plates16</p> <p style="padding-left: 20px;">Labeling Fiber Backbone21</p> <p style="padding-left: 20px;">Labeling Horizontal Cables17</p> <p style="padding-left: 20px;">Labeling Patch Panels18</p> <p style="padding-left: 20px;">Labeling Pathways21</p> <p style="padding-left: 20px;">Labeling Racks18</p> <p>Ladder Rack55</p> <p>L-COM66</p> <p>LINKWARE8</p> <p>Liquid Tight Cable Gland66</p> <p>MAXCELL66</p> <p>METASYS12</p> <p>MIDDLE ATLANTIC66</p> <p>Mini-Com68</p> <p>NBFU7</p> <p>NBS7</p> <p>NEC7, 50</p> <p>NEMA7</p> <p>NFPA7</p> <p>Office12</p> <p>OSHA7</p> <p>OSP50</p> <p>OSP CAT6A74</p> <p>OSP CAT6A Patch Cord66</p> <p>OTDR50</p> <p>Out Side Plant24</p> <p>Outdoor (Altose® Loose Tube)62</p> <p>Outlet Boxes & Lids59</p> <p>PANDUIT67–72</p> <p>Patch Cords63, 71</p> <p>Patch Panels / Filler Panels68</p> <p>Pathways (INDOOR)34, 36</p> <p style="padding-left: 20px;">Cable Entry37</p> <p style="padding-left: 20px;">Fire Rated Riser Pathways37</p> <p style="padding-left: 20px;">Horizontal Conduit Patways & Sleeves36</p> <p>PDU64</p> <p>Preuim Edge Solutions63</p> <p>Printer12</p> <p>Purpose6</p> <p>Racks / Wire Management67</p> <p>RCDD8</p>	<p>Referenced Standards 7</p> <p>service loop 25</p> <p>SIEMON 72</p> <p>SM 50</p> <p>STI..... 73, 72–73</p> <p>Submittals 8</p> <p style="padding-left: 20px;">Post-Installation 8</p> <p style="padding-left: 40px;">As-Built Drawings..... 9</p> <p style="padding-left: 40px;">Installation is Complete When..... 10</p> <p style="padding-left: 40px;">Test Results..... 8</p> <p style="padding-left: 40px;">Warranties 10</p> <p style="padding-left: 20px;">Pre-Installation 8</p> <p style="padding-left: 40px;">Installer Requirements 8</p> <p>SUPERIOR ESSEX 74, 73–74</p> <p>Surface Raceway and Vertical Outlet Pole 14</p> <p style="padding-left: 20px;">Fittings 14</p> <p style="padding-left: 20px;">Outlet Boxes 14</p> <p style="padding-left: 20px;">Single Channel Surface Raceway System 14</p> <p>Surge Protection 65</p> <p>TBB 33</p> <p>Telecommunication Cabinet (TC) 25</p> <p>Telecommunications Outlet 12</p> <p style="padding-left: 20px;">Quantities and Locations 12</p> <p style="padding-left: 20px;">Surface Mount Boxes 13</p> <p style="padding-left: 20px;">Types and Parts 12</p> <p>Telecommunications Room</p> <p style="padding-left: 20px;">Cable Management (TR) 30</p> <p style="padding-left: 20px;">Copper Patch Cables (TR) 30</p> <p style="padding-left: 20px;">Electrical Power (TR) 28</p> <p style="padding-left: 20px;">Fiber Patch Cables (TR) 30</p> <p style="padding-left: 20px;">Fire Suppction (TR) 28</p> <p style="padding-left: 20px;">HVAC (TR) 28</p> <p style="padding-left: 20px;">Ladder Rack (TR) 27</p> <p style="padding-left: 20px;">Lighting (TR) 28</p> <p style="padding-left: 20px;">Patch Cable Lengths Drawing 31–32</p> <p style="padding-left: 20px;">Racks (TR) 26</p> <p style="padding-left: 20px;">Typical Rack Elevations 29</p> <p>Telecommunications Room (TR) 25</p> <p>TGB 33</p> <p>Time Clock 12</p> <p>TMGB 33</p> <p>TR 50</p> <p>TUGMAN 12</p> <p>U-Hook 54</p> <p>UL 7</p> <p>Wall Enclosure 68</p> <p>WAO 50</p> <p>Wireless Access Point 12</p>
---	--

Document Version Information

Revision History

Date	Version	Section/Page	Description of Change	Originator of Change
05/24-26/11	1.0	All	New Document created from original; restyled to TS branding; headers & footers added; figures labeled for clarity; (still needs grammar review)	Ellen Hayes
06/16/2011	1.1	All	Added additional information to all sections of the document.	Tim Weaver
06/22/11	1.2	All	Reformat to styles; spell check, create updated TOC, Appendices	Ellen Hayes
06/23/11	1.3	Glossary	Add glossary terms; Add Appendix E information	Ellen Hayes
06/23/11	1.4	All	Final review of document	Roger Raymond
07/01/11	1.5	Misc.	Added sentences; change to a title	Tim Weaver
07/06/11	1.6	Misc.	Revise; create new PDF & publish	Tim Weaver / Ellen Hayes
07/06/11	1.7	Misc.	Delete DRAFT watermark, add Disclaimer information, revise footer, create new PDF & publish	Tim Weaver / Ellen Hayes
07/14/11 & 7/25/11	1.8	Misc.	Mark index terms per Tim's markups; generate Index	Ellen Hayes
6/6/2013	2.0	All	Added additional information to all sections of the document.	Tim Weaver
8/12/13	2.5	DC section	Added Data Center (DC) standards & parts.	Tim Weaver
8/12/13	2.6	Fire Suppression	Reworded	Tim Weaver
8/12/14	2.7	Labeling, Horizontal Cabling, TC's, Patch Cables, Pathways & Appendix	Elaborated on existing requirements & added additional approved parts.	Tim Weaver
5/12/16	2.9	All	Reorganized the document layout, added information to all sections of the document. Added and removed acceptable materials.	Michael Ireland Jr. Tim Weaver

	Version: 2.9	
	Date: 05/2016	
Official Documentation: Cabling Standards		

Document Control

Control Title	Description
Technical Reviewer/ Document Process Owner	Jim Lizotte, Michael Journigan & Tim Weaver
Document Retention	Ongoing
Document Review Cycle	Yearly